



TERMA

SINCE 1990

Heating Products **2019/2020**

Cast Iron Radiators

Cast iron colour & finish selection.

In addition to 192 standard RAL colours, Terma offers special colours and special decorative finishes. Upon client's request, Terma is able to provide radiators and accessories in individually chosen finishes.

Cast iron special colour selection

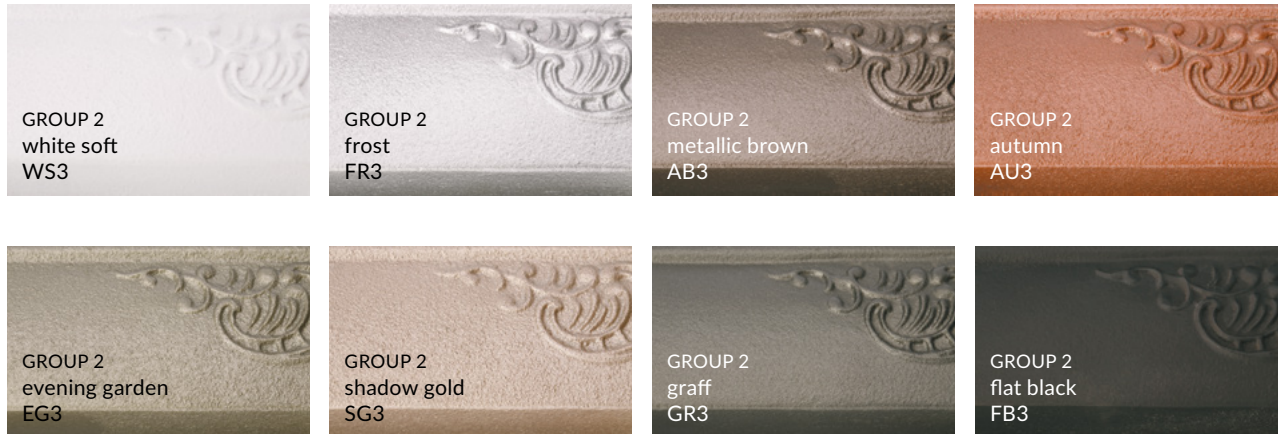

Cast iron decorativ finishes



* exposed ornament can be finished in any one special colour from the special colour selection

** special finish offered in both painted (Antique Copper, group 4) or galvanic finishes (Galvanic Copper, group 5)

*** special finish offered in both painted (Antique Brass, group 4) or galvanic finishes (Galvanic Brass, group 5)

Bart

① s. 270



Radiator

Free standing Bart 640 ↑ x 852 ↔ LP, colour: autumn, product and configuration code: WGBRF064085 LAU3LP

Valves and accessories

Angled manual valve set Minimalist, chrome, TGZRCR017

Pipe masking set – 160 mm, chrome, TGPCR004



Kaszub ⓘ s. 274

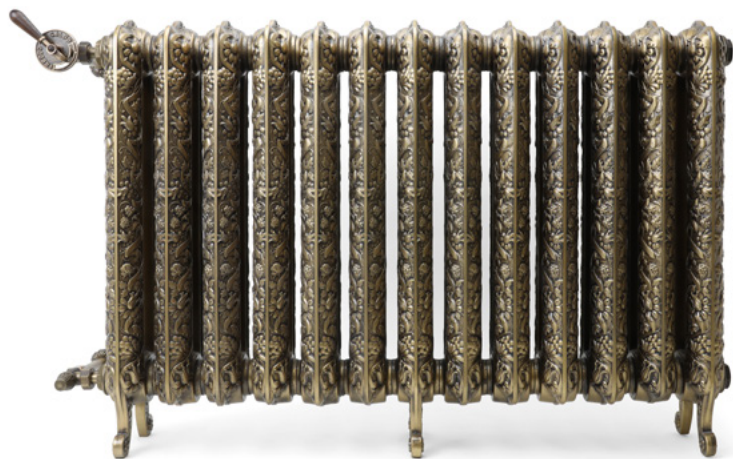

Radiator

Free standing Kaszub 720↑ x 1098↔ LP, colour: antique brass, product and configuration code: WGKAF072109 LAN5LP

Valves and accessories

Angled manual valve set Classic Art, brushed bronze, TGERANT03

Pipe masking set Artistic, brushed bronze, TGPBR001



Radiator

Free standing Kaszub 920↑ x 688↔ LP, colour: raw metal, product and configuration code: WGKAF092068 LZE3LP

Valves and accessories

Angled thermostatic manual valve set Artistic, anthracite, TGETAN002

Artistic pipe masking set, anthracite, TGPAN001



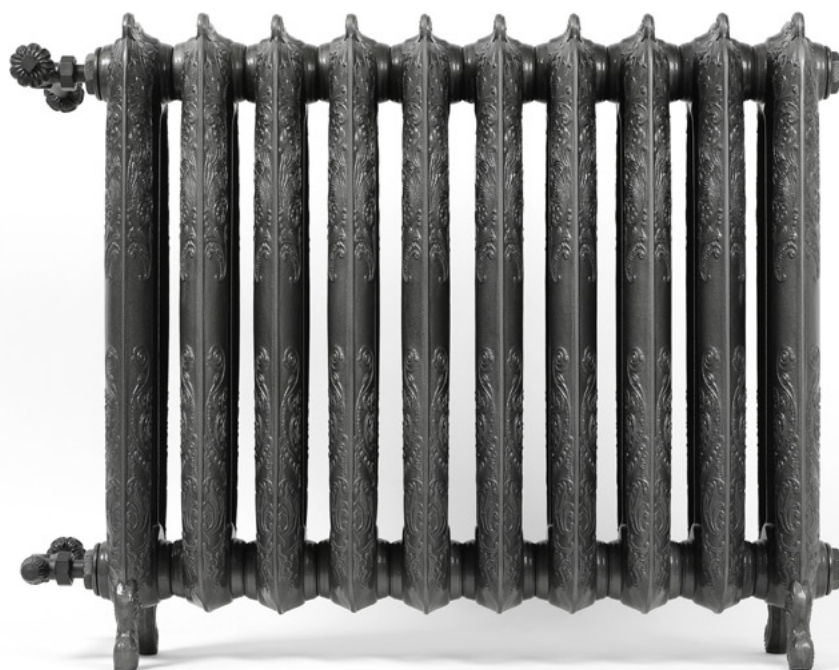

Radiator

Free standing Oxford 710↑ x 852↔ LP, colour: raw metal, product and configuration code: WGOXF071085 LZE3LP

Valves and accessories

Angled thermostatic manual valve set Artistic, anthracite, TGETAN002

Artistic pipe masking set, anthracite, TGPAN001



Plain [ⓘ] s. 286

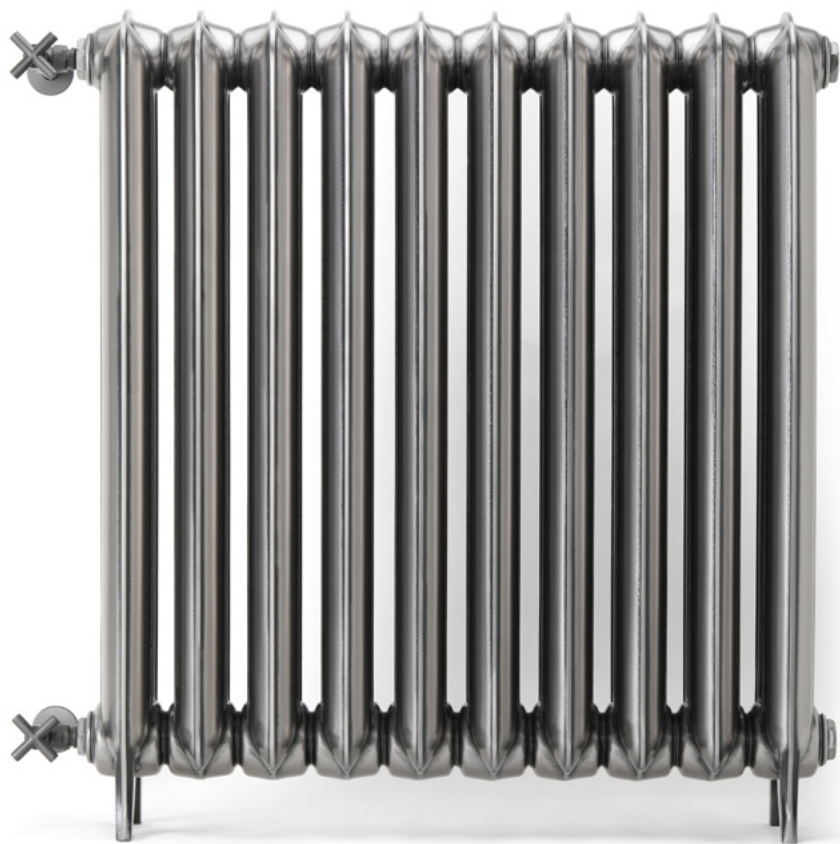

Radiator

Free standing Plain 920 ↓ x 852 ↔ LP, colour: polished metal, product and configuration code: WGPLF092085 LZE2LP

Valves and accessories

Angled manual valve set Minimalist, anthracite, TGERAN002

Pipe masking set – 160 mm, anthracite, TGPAN002



Plain 3 column ① s. 296

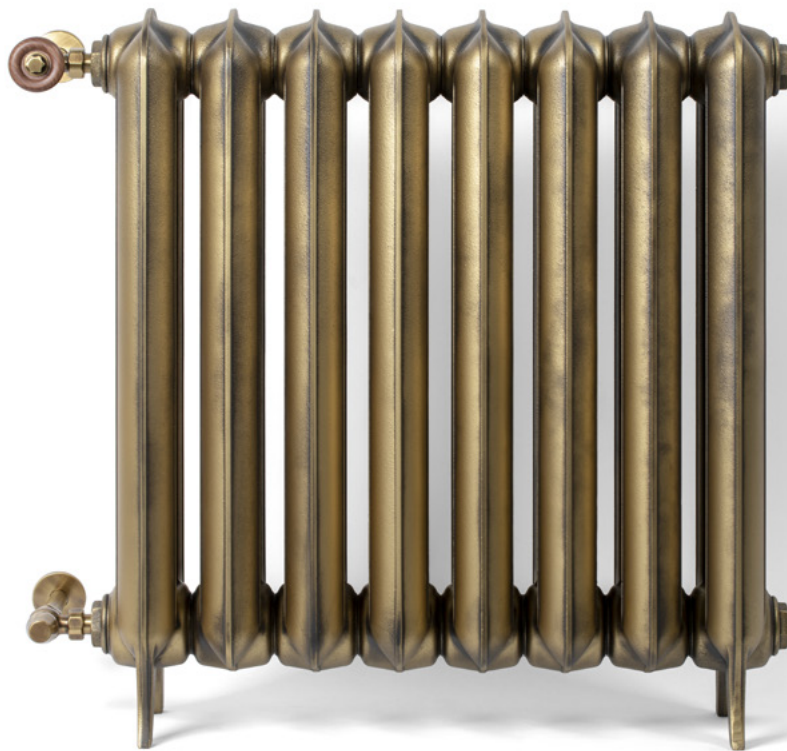

Radiator

Free standing Plain 3 column 720 \updownarrow x 688 \leftrightarrow LP, colour: antique brass, product and configuration code: WGP3F072068
LAN5LP

Valves and accessories

WOOD thermostatic angled valve set, brushed bronze, TGERAN002
Pipe masking set – 160 mm, brushed bronze, TGPBR002



Radiator

Free standing Plain 3 column 920 ↑ x 1098 ↔ LP, colour: raw metal,
product and configuration code: WGP3F092109 LZE3LP

Valves and accessories

Angled manual valve set Minimalist, anthracite, TGERAN002
Pipe masking set – 160 mm, anthracite, TGPAN002



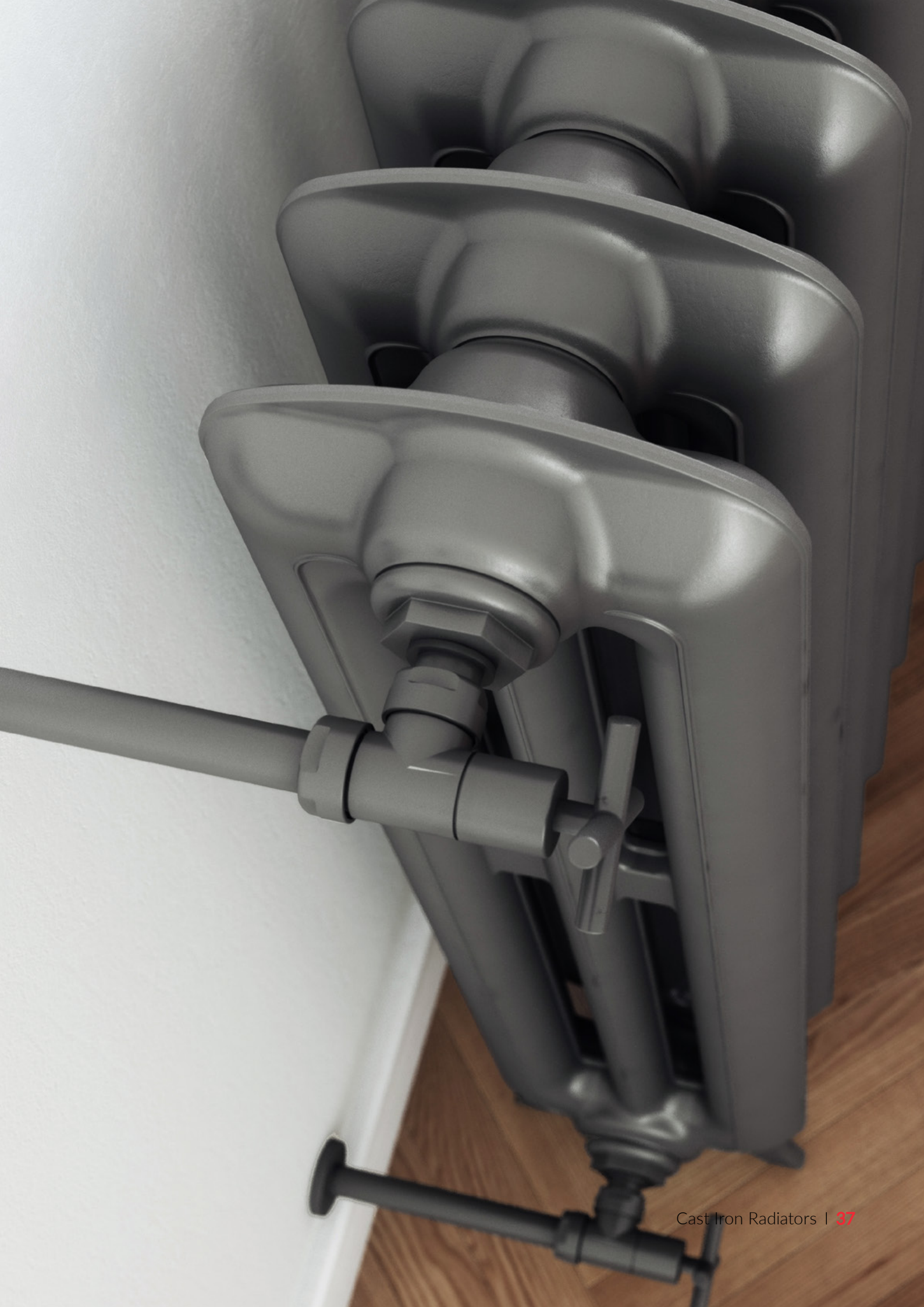

Plain Towel Rail ⓘ s. 304



Radiator

Plain Towel Rail 900↑ x 650↔ AX, colour: galvanic copper, chrome, product and configuration code: WGNTR090065 LGC5LP

Valves and accessories

Star Angled manual valves set, chrome, TGERSTCR01

Pipe masking set – 160 mm, chrome, TGPCR004







Radiator

Plain Towel Rail 900↑ x 490↔ AX, colour:
raw metal, chrome, product and configuration code:

WGNTRO90049 LZE3AX

Valves and accessories

Angled manual valve set Minimalist, chrome, TGZRCR017

Pipe masking set – 160 mm, chrome, TGPCR004

Cast iron radiators

Technical Information



Standard connections:



Available sizes:

Wall mounted

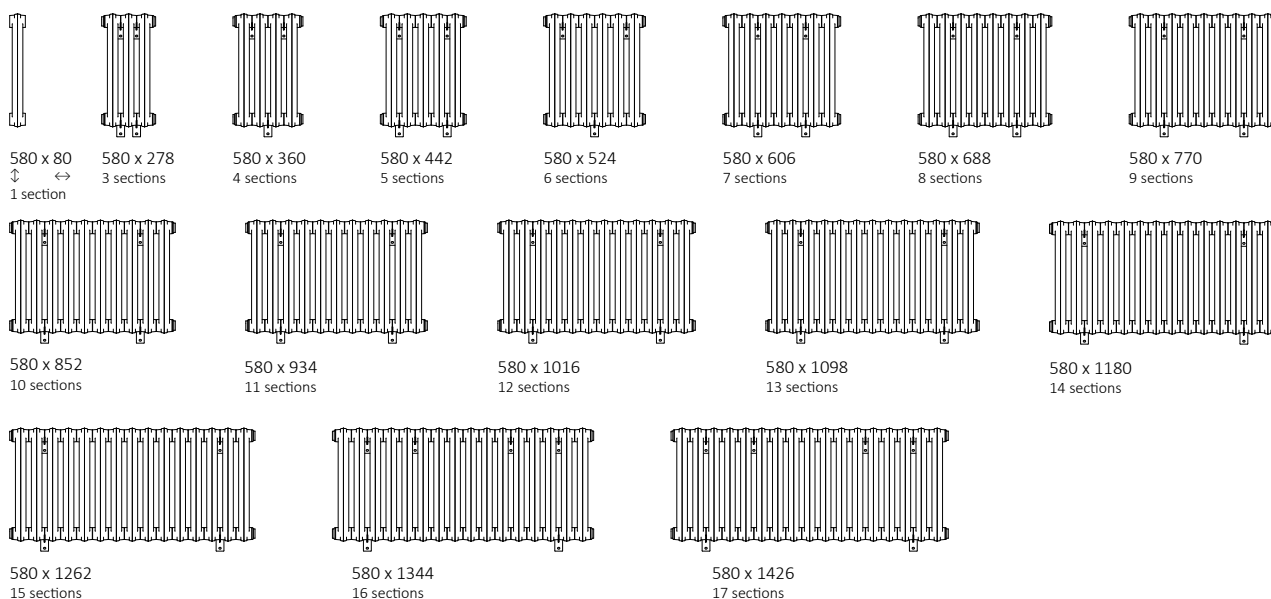

Free standing

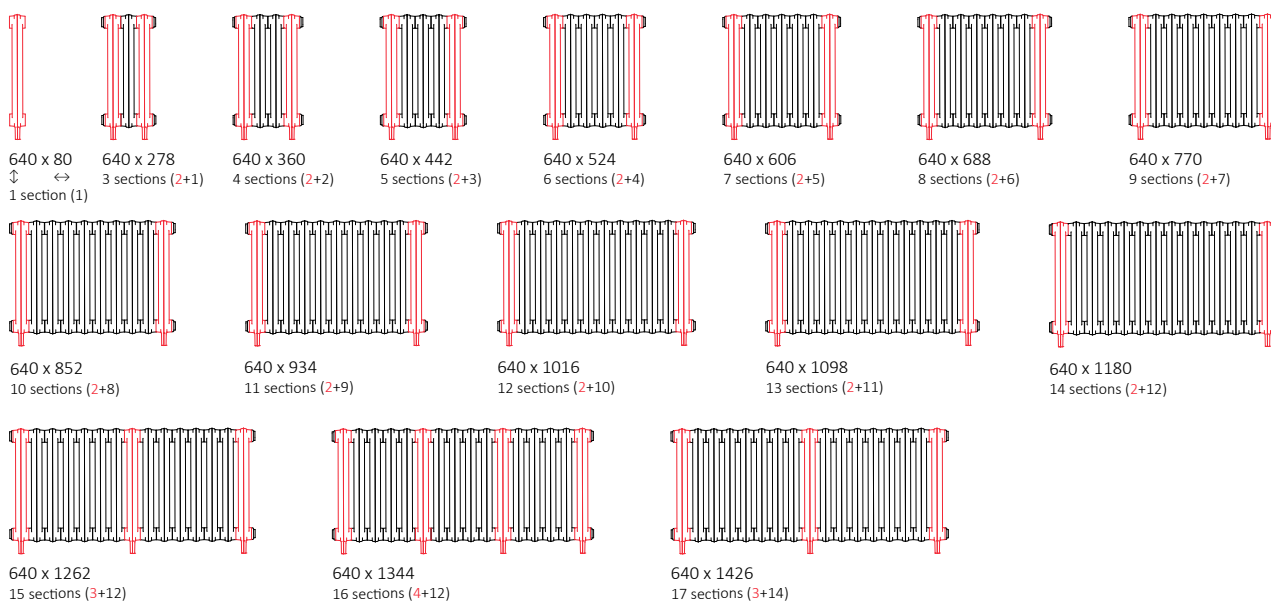

Wall mounted

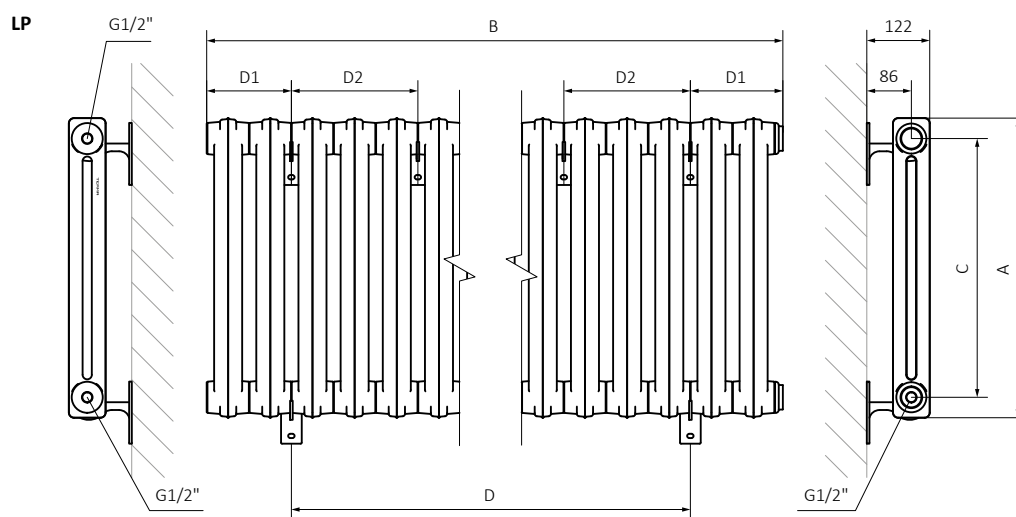

A – Height B – Width C – Distance between pipe centres D – Horizontal distance between mounting bracket centres

Free standing

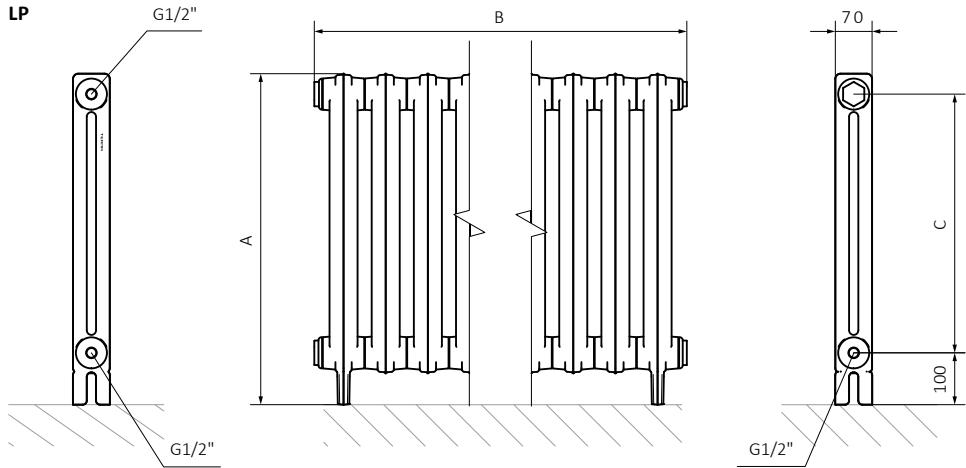



Standard connections:



Available sizes:

Wall mounted

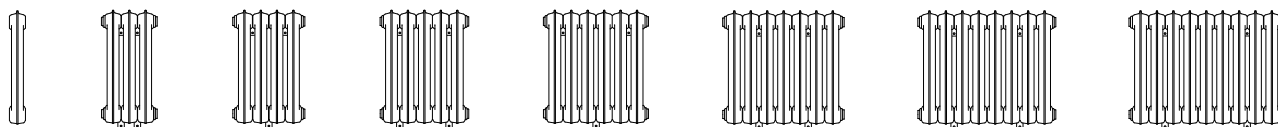

660 x 80 1 section 660 x 278 3 sections 660 x 360 4 sections 660 x 442 5 sections 660 x 524 6 sections 660 x 606 7 sections 660 x 688 8 sections 660 x 770 9 sections

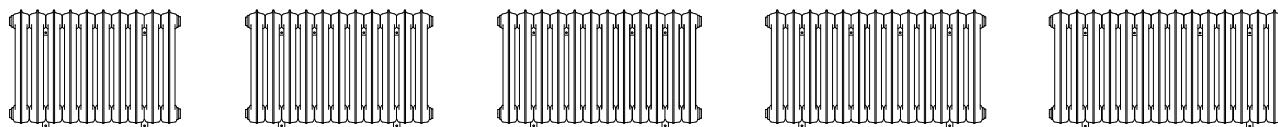

660 x 852 10 sections 660 x 934 11 sections 660 x 1016 12 sections 660 x 1098 13 sections 660 x 1180 14 sections

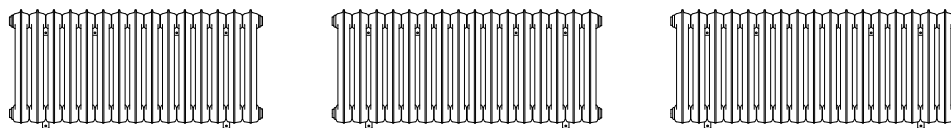

660 x 1262 15 sections 660 x 1344 16 sections 660 x 1426 17 sections

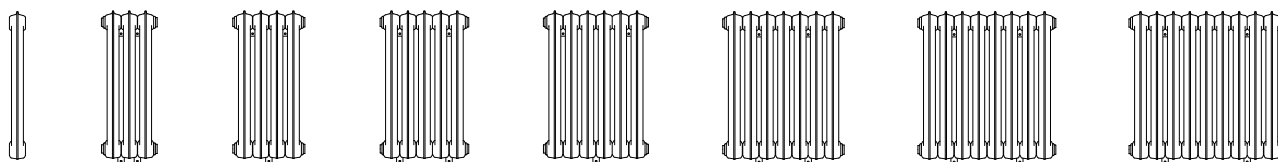

860 x 80 1 section 860 x 278 3 sections 860 x 360 4 sections 860 x 442 5 sections 860 x 524 6 sections 860 x 606 7 sections 860 x 688 8 sections 860 x 770 9 sections

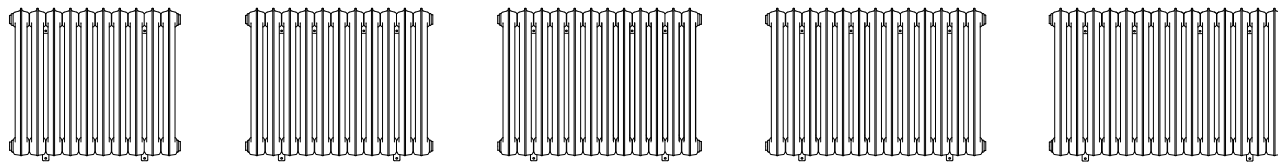

860 x 852 10 sections 860 x 934 11 sections 860 x 1016 12 sections 860 x 1098 13 sections 860 x 1180 14 sections

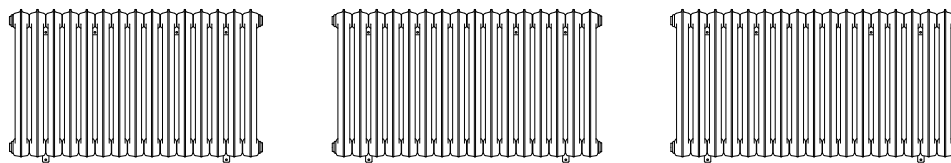

860 x 1262 15 sections 860 x 1344 16 sections 860 x 1426 17 sections

We recommend: Angled manual valve set Classic Art for LP connection – see page 677



Pipe masking set Artistic – see page 681





Free standing



Specifications:

Working pressure: 1000 kPa Maximum operating temperature: 95°C

A ↑ [mm]	B ↔ [mm]	C [mm]	75/65/20°C [W]	55/45/20°C [W]	D [mm]	D1 [mm]	D2 [mm]	 [dm ²]	 [kg]	Product code <small>(Configuration code p. 787)</small>
Wall mounted										
660	80	560	120	65	–	–	–	3,05	10,8	WGKAB066008
660	278	560	361	195	82	98	–	9,16	33,5	WGKAB066027
660	360	560	481	260	–	98	–	12,21	44,3	WGKAB066036
660	442	560	602	325	246	98	–	15,27	55,1	WGKAB066044
660	524	560	722	391	–	98	–	18,32	65,9	WGKAB066052
660	606	560	842	456	246	180	–	21,37	76,7	WGKAB066060
660	688	560	962	521	–	180	–	24,42	87,5	WGKAB066068
660	770	560	1083	586	410	180	–	27,48	98,3	WGKAB066077
660	852	560	1203	651	492	180	–	30,53	109,1	WGKAB066085
660	934	560	1323	716	574	180	164	33,58	119,9	WGKAB066093
660	1016	560	1444	781	656	180	164	36,64	130,7	WGKAB066101
660	1098	560	1564	846	738	180	246	39,69	141,5	WGKAB066109
660	1180	560	1684	911	820	180	246	42,74	152,3	WGKAB066118
660	1262	560	1805	976	902	180	246	45,8	163,1	WGKAB066126
660	1344	560	1925	1041	984	180	246	48,85	173,9	WGKAB066134
660	1426	560	2045	1107	1066	180	246	51,9	184,7	WGKAB066142
860	80	760	149	80	–	–	–	4,14	14,0	WGKAB086008
860	278	760	447	239	82	98	–	12,42	43,1	WGKAB086027
860	360	760	596	318	–	98	–	16,56	57,1	WGKAB086036
860	442	760	745	398	246	98	–	20,70	71,1	WGKAB086044
860	524	760	894	477	–	98	–	24,84	85,1	WGKAB086052
860	606	760	1043	557	246	180	–	28,98	99,1	WGKAB086060
860	688	760	1192	636	328	180	–	33,12	113,1	WGKAB086068
860	770	760	1341	716	410	180	–	37,26	127,1	WGKAB086077
860	852	760	1490	795	492	180	–	41,40	141,1	WGKAB086085
860	934	760	1639	875	574	180	164	45,54	155,1	WGKAB086093
860	1016	760	1788	954	656	180	164	49,68	169,1	WGKAB086101
860	1098	760	1937	1034	738	180	246	53,82	183,1	WGKAB086109
860	1180	760	2086	1113	820	180	246	57,96	197,1	WGKAB086118
860	1262	760	2235	1193	902	180	246	62,10	211,1	WGKAB086126
860	1344	760	2384	1272	984	180	246	66,24	225,1	WGKAB086134
860	1426	760	2533	1352	1066	180	246	70,38	239,1	WGKAB086142

A ↓ [mm]	B ↔ [mm]	C [mm]	75/65/20°C [W]	55/45/20°C [W]	D [mm]	D1 [mm]	D2 [mm]	 [dm²]	 [kg]	Product code <small>(Configuration code p. 787)</small>
Free standing										
720	80	560	120	65	–	–	–	3,05	11,3	WGKAF072008
720	278	560	360	195	–	–	–	9,16	35,1	WGKAF072027
720	360	560	480	260	–	–	–	12,21	46,1	WGKAF072036
720	442	560	600	325	–	–	–	15,27	57,1	WGKAF072044
720	524	560	720	390	–	–	–	18,32	68,1	WGKAF072052
720	606	560	840	454	–	–	–	21,37	79,1	WGKAF072060
720	688	560	960	519	–	–	–	24,42	90,1	WGKAF072068
720	770	560	1080	584	–	–	–	27,48	101,1	WGKAF072077
720	852	560	1200	649	–	–	–	30,53	112,1	WGKAF072085
720	934	560	1320	714	–	–	–	33,58	123,1	WGKAF072093
720	1016	560	1440	779	–	–	–	36,64	134,1	WGKAF072101
720	1098	560	1560	844	–	–	–	39,69	145,6	WGKAF072109
720	1180	560	1680	909	–	–	–	42,74	157,1	WGKAF072118
720	1262	560	1800	974	–	–	–	45,8	167,6	WGKAF072126
720	1344	560	1920	1039	–	–	–	48,85	179,1	WGKAF072134
720	1426	560	2040	1104	–	–	–	51,9	189,6	WGKAF072142
920	80	760	149	80	–	–	–	4,14	15,0	WGKAF092008
920	278	760	447	239	–	–	–	12,42	45,7	WGKAF092027
920	360	760	596	318	–	–	–	16,56	59,9	WGKAF092036
920	442	760	745	398	–	–	–	20,70	74,1	WGKAF092044
920	524	760	894	477	–	–	–	24,84	88,3	WGKAF092052
920	606	760	1043	557	–	–	–	28,98	102,5	WGKAF092060
920	688	760	1192	636	–	–	–	33,12	116,7	WGKAF092068
920	770	760	1341	716	–	–	–	37,26	130,9	WGKAF092077
920	852	760	1490	795	–	–	–	41,40	145,1	WGKAF092085
920	934	760	1639	875	–	–	–	45,54	159,3	WGKAF092093
920	1016	760	1788	954	–	–	–	49,68	173,5	WGKAF092101
920	1098	760	1937	1034	–	–	–	53,82	188,7	WGKAF092109
920	1180	760	2086	1113	–	–	–	57,96	203,9	WGKAF092118
920	1262	760	2235	1193	–	–	–	62,10	217,1	WGKAF092126
920	1344	760	2384	1272	–	–	–	66,24	232,3	WGKAF092134
920	1426	760	2533	1352	–	–	–	70,38	245,5	WGKAF092142

Radiators made up of 13 sections and more are delivered in two or more batteries.

Wall mounted

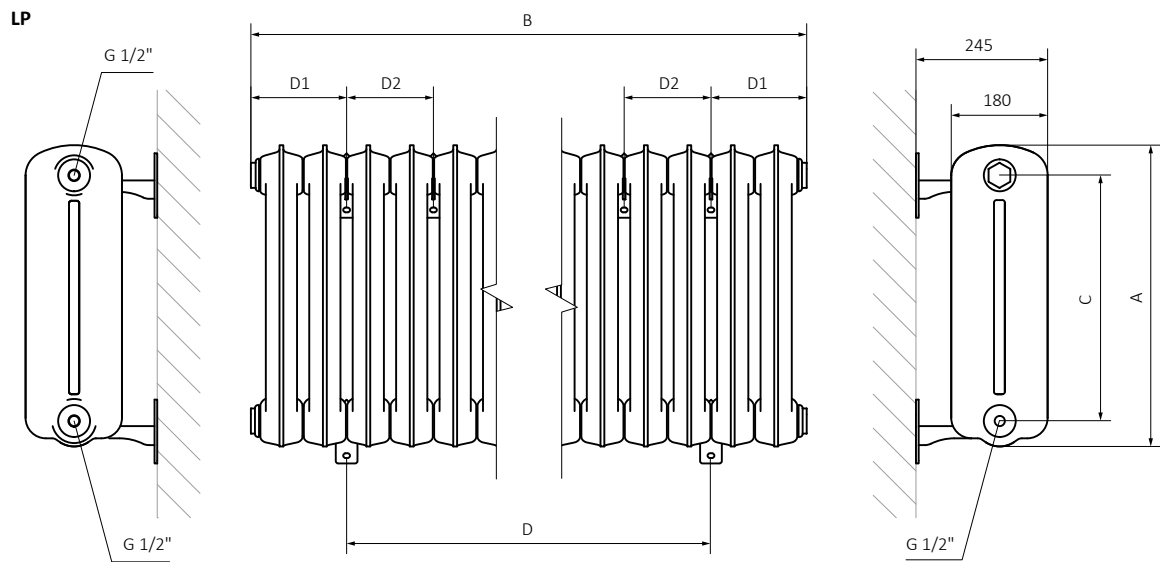

A – Height B – Width C – Distance between pipe centres D – Horizontal distance between mounting bracket centres

Free standing

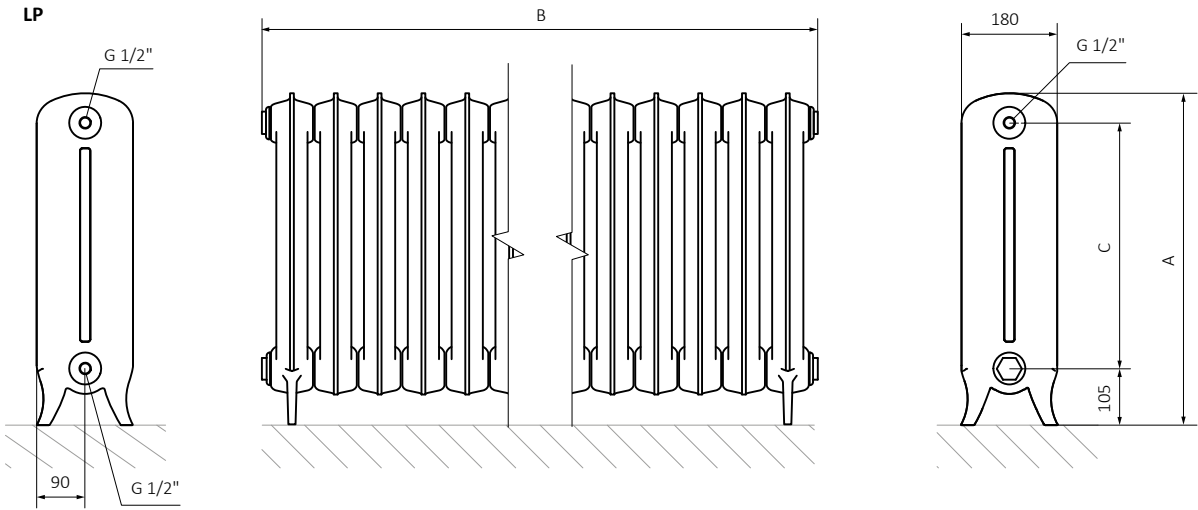



Standard connections:



Available sizes:

Wall mounted

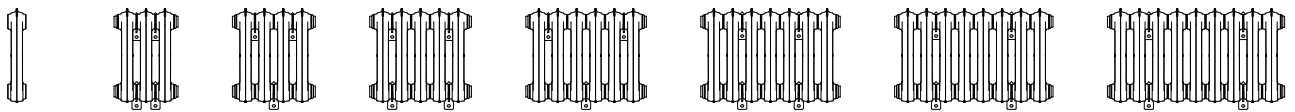

410 x 80 1 section 410 x 278 3 sections 410 x 360 4 sections 410 x 442 5 sections 410 x 524 6 sections 410 x 606 7 sections 410 x 688 8 sections 410 x 770 9 sections

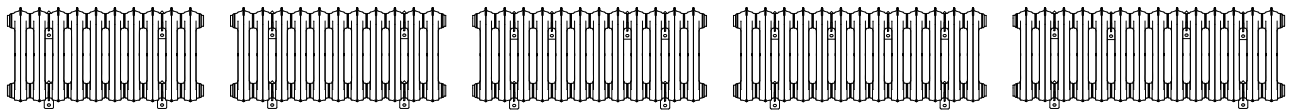

410 x 852 10 sections 410 x 934 11 sections 410 x 1016 12 sections 410 x 1098 13 sections 410 x 1180 14 sections

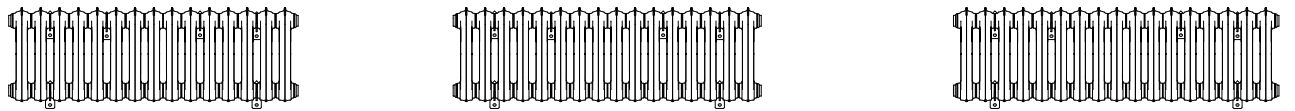

410 x 1262 15 sections 410 x 1344 16 sections 410 x 1426 17 sections

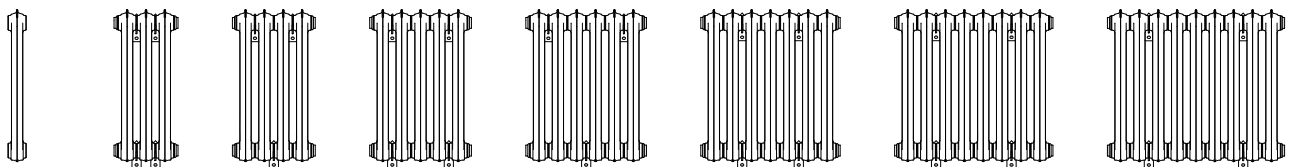

660 x 80 1 sections 660 x 278 3 sections 660 x 360 4 sections 660 x 442 5 sections 660 x 524 6 sections 660 x 606 7 sections 660 x 688 8 sections 660 x 770 9 sections

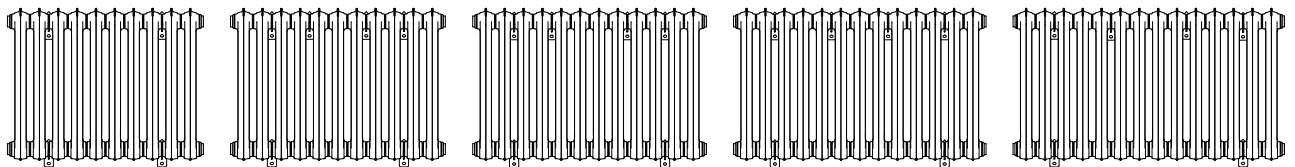

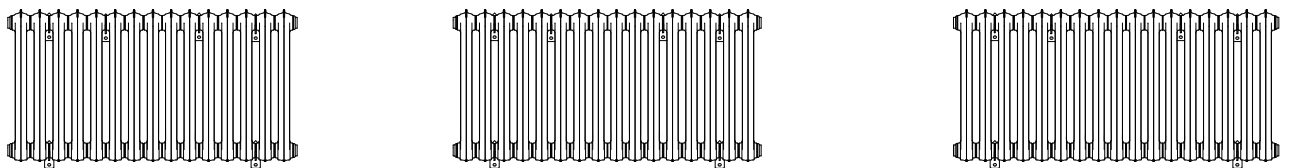

660 x 852 10 sections 660 x 934 11 sections 660 x 1016 12 sections 660 x 1098 13 sections 660 x 1180 14 sections





660 x 1262 15 sections 660 x 1344 16 sections 660 x 1426 17 sections

Specifications:

Working pressure: 1000 kPa Maximum operating temperature: 95°C

A ↑ [mm]	B ↔ [mm]	C [mm]	75/65/20°C [W]	55/45/20°C [W]	D [mm]	D1 [mm]	D2 [mm]	 [dm ³]	 [kg]	Product code <small>(Configuration code p. 787)</small>
Wall mounted										
410	80	297	86	44	—	—	—	1,65	8,10	WGOXB041008
410	278	297	257	133	82	98	—	4,95	24,70	WGOXB041027
410	360	297	343	177	—	98	—	6,60	33,00	WGOXB041036
410	442	297	429	222	246	98	—	8,25	41,30	WGOXB041044
410	524	297	515	266	—	98	—	9,90	49,60	WGOXB041052
410	606	297	601	310	246	180	—	11,55	57,90	WGOXB041060
410	688	297	686	355	—	180	—	13,20	66,20	WGOXB041068
410	770	297	772	399	410	180	—	14,85	74,50	WGOXB041077
410	852	297	858	443	492	180	—	16,50	82,80	WGOXB041085
410	934	297	944	488	574	180	—	18,15	91,10	WGOXB041093
410	1016	297	1030	532	656	180	164	19,80	99,40	WGOXB041101
410	1098	297	1115	577	738	180	164	21,45	107,70	WGOXB041109
410	1180	297	1201	621	820	180	246	23,10	116,00	WGOXB041118
410	1262	297	1287	665	902	180	246	24,75	124,30	WGOXB041126
410	1344	297	1373	710	984	180	246	26,40	132,60	WGOXB041134
410	1426	297	1459	754	1066	180	246	28,05	140,90	WGOXB041142
660	80	555	143	76	—	—	—	2,25	14,70	WGOXB066008
660	278	555	429	227	82	98	—	6,75	44,50	WGOXB066027
660	360	555	572	303	—	98	—	9,00	59,40	WGOXB066036
660	442	555	715	379	246	98	—	11,25	74,30	WGOXB066044
660	524	555	858	454	—	98	—	13,50	89,20	WGOXB066052
660	606	555	1001	530	246	180	—	15,75	104,10	WGOXB066060
660	688	555	1144	606	328	180	—	18,00	119,00	WGOXB066068
660	770	555	1287	682	410	180	—	20,25	133,90	WGOXB066077
660	852	555	1430	757	492	180	—	22,50	148,80	WGOXB066085
660	934	555	1573	833	574	180	164	24,75	163,70	WGOXB066093
660	1016	555	1716	909	656	180	164	27,00	178,60	WGOXB066101
660	1098	555	1859	985	738	180	246	29,25	193,50	WGOXB066109
660	1180	555	2002	1060	820	180	246	31,50	208,40	WGOXB066118
660	1262	555	2145	1136	902	180	246	33,75	223,30	WGOXB066126
660	1344	555	2288	1212	984	180	246	36,00	238,20	WGOXB066134
660	1426	555	2431	1288	1066	180	246	38,25	253,10	WGOXB066142

Radiators made up of 13 sections and more are delivered in two or more batteries.

A ↑ [mm]	B ↔ [mm]	C [mm]	75/65/20°C [W]	55/45/20°C [W]	D [mm]	D1 [mm]	D2 [mm]	 [dm³]	 [kg]	Product code <small>(Configuration code p. 787)</small>
Free standing										
470	80	297	86	44	–	–	–	1,65	8,7	WGOXF047008
470	278	297	257	133	–	–	–	4,95	25,9	WGOXF047027
470	360	297	343	177	–	–	–	6,60	34,0	WGOXF047036
470	442	297	429	222	–	–	–	8,25	42,1	WGOXF047044
470	524	297	515	266	–	–	–	9,90	50,2	WGOXF047052
470	606	297	601	310	–	–	–	11,55	58,3	WGOXF047060
470	688	297	686	355	–	–	–	13,20	66,4	WGOXF047068
470	770	297	772	399	–	–	–	14,85	74,5	WGOXF047077
470	852	297	858	443	–	–	–	16,50	82,6	WGOXF047085
470	934	297	944	488	–	–	–	18,15	90,7	WGOXF047093
470	1016	297	1030	532	–	–	–	19,80	98,8	WGOXF047101
470	1098	297	1115	577	–	–	–	21,45	107,5	WGOXF047109
470	1180	297	1201	621	–	–	–	23,10	116,2	WGOXF047118
470	1262	297	1287	665	–	–	–	24,75	115,6	WGOXF047126
470	1344	297	1373	710	–	–	–	26,40	132,4	WGOXF047134
470	1426	297	1459	754	–	–	–	28,05	139,9	WGOXF047142
710	80	555	143	76	–	–	–	2,25	15,3	WGOXF071008
710	278	555	429	227	–	–	–	6,75	45,7	WGOXF071027
710	360	555	572	303	–	–	–	9,00	60,4	WGOXF071036
710	442	555	715	379	–	–	–	11,25	75,1	WGOXF071044
710	524	555	858	454	–	–	–	13,50	89,8	WGOXF071052
710	606	555	1001	530	–	–	–	15,75	104,5	WGOXF071060
710	688	555	1144	606	–	–	–	18,00	119,2	WGOXF071068
710	770	555	1287	682	–	–	–	20,25	133,9	WGOXF071077
710	852	555	1430	757	–	–	–	22,50	148,6	WGOXF071085
710	934	555	1573	833	–	–	–	24,75	163,3	WGOXF071093
710	1016	555	1716	909	–	–	–	27,00	178,0	WGOXF071101
710	1098	555	1859	985	–	–	–	29,25	193,3	WGOXF071109
710	1180	555	2002	1060	–	–	–	31,50	208,6	WGOXF071118
710	1262	555	2145	1136	–	–	–	33,75	208,0	WGOXF071126
710	1344	555	2288	1212	–	–	–	36,00	238,0	WGOXF071134
710	1426	555	2431	1288	–	–	–	38,25	252,1	WGOXF071142

Radiators made up of 13 sections and more are delivered in two or more batteries.

Wall mounted

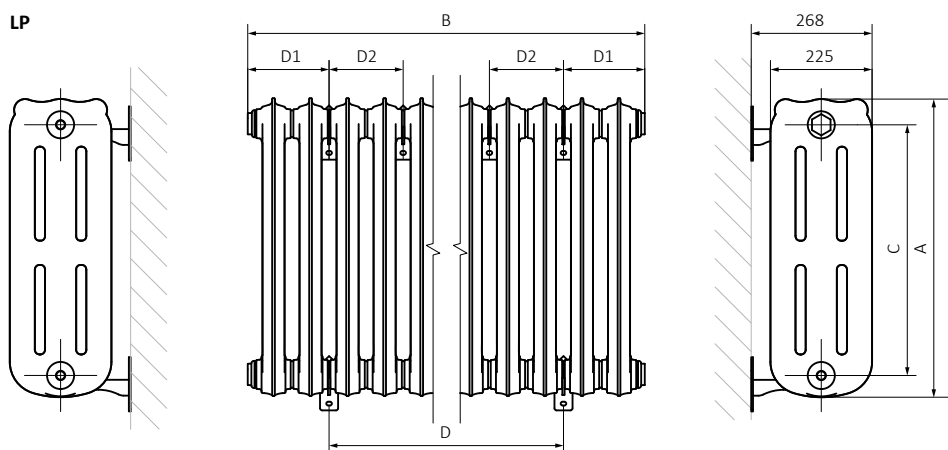
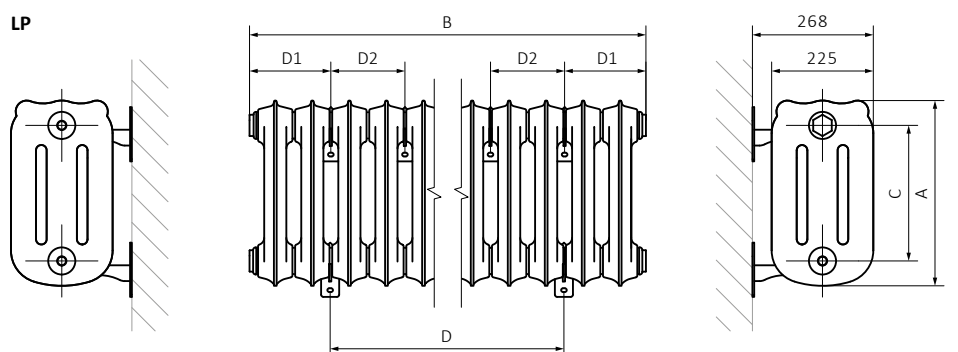

A – Height B – Width C – Distance between pipe centres D – Horizontal distance between mounting bracket centres

Free standing

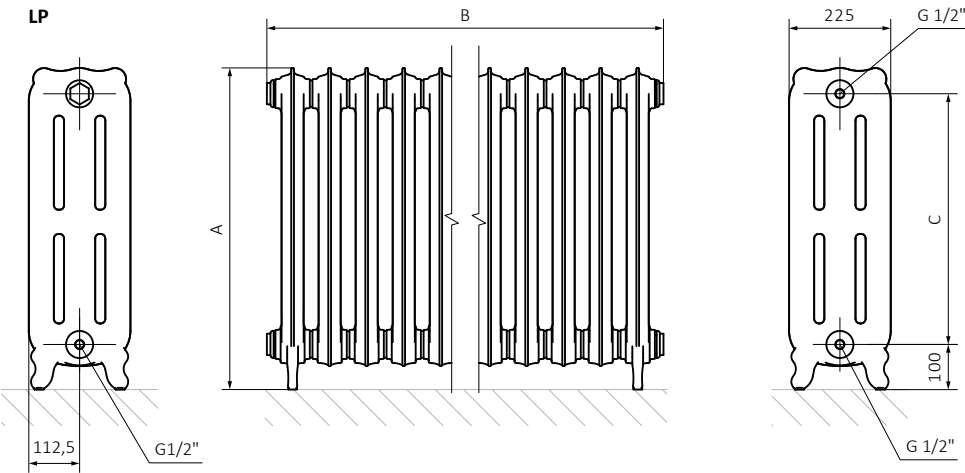
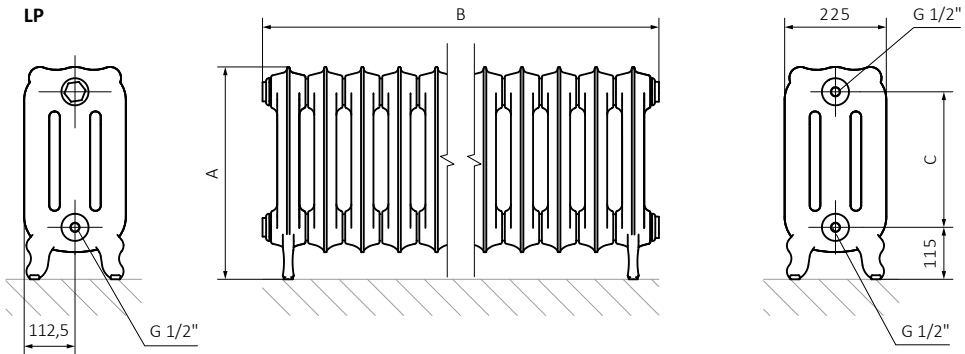



Standard connections:



Available sizes:

Wall mounted



460 x 80
1 section

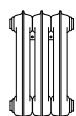

460 x 278
3 sections

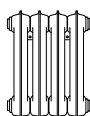

460 x 360
4 sections

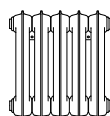

460 x 442
5 sections

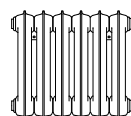

460 x 524
6 sections

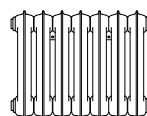

460 x 606
7 sections

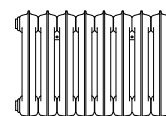

460 x 688
8 sections

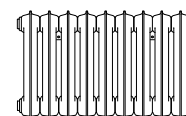

460 x 770
9 sections

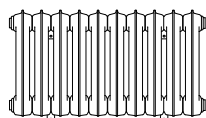

460 x 852
10 sections

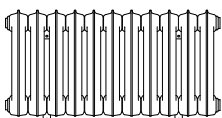

460 x 934
11 sections

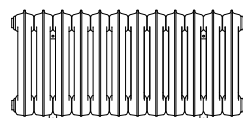

460 x 1016
12 sections

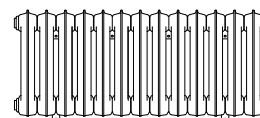

460 x 1098
13 sections

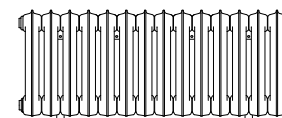

460 x 1180
14 sections

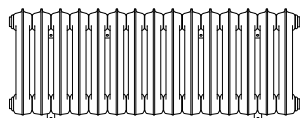

460 x 1262
15 sections

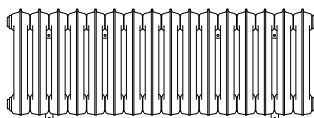

460 x 1344
16 sections

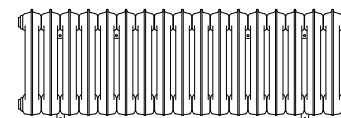

460 x 1426
17 sections



560 x 80
1 section

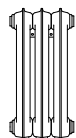

560 x 278
3 sections

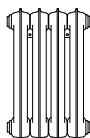

560 x 360
4 sections

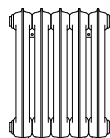

560 x 442
5 sections

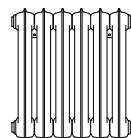

560 x 524
6 sections

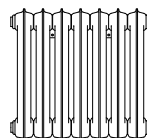

560 x 606
7 sections

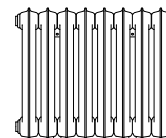

560 x 688
8 sections

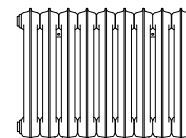

560 x 770
9 sections

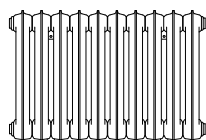

560 x 852
10 sections

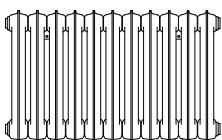

560 x 934
11 sections

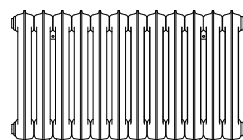

560 x 1016
12 sections

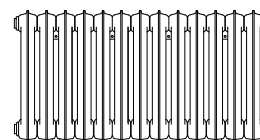

560 x 1098
13 sections

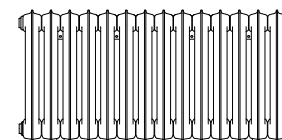

560 x 1180
14 sections

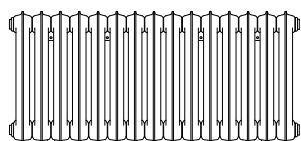

560 x 1262
15 sections

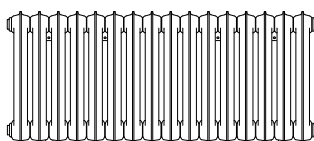

560 x 1344
16 sections

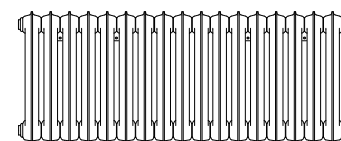

560 x 1426
17 sections

We recommend: Angled manual valve set Minimalist
for LP connection – see page 678



Pipe masking set – 160 mm
– see page 681



660 x 80
1 section

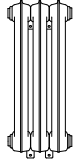

660 x 278
3 sections

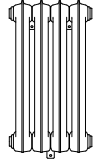

660 x 360
4 sections

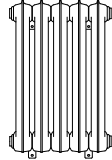

660 x 442
5 sections

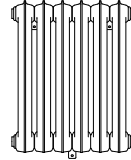

660 x 524
6 sections

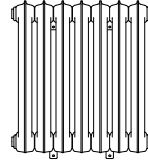

660 x 606
7 sections

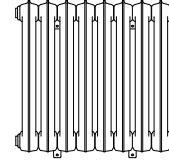

660 x 688
8 sections

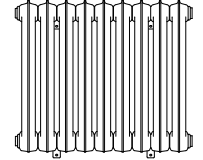

660 x 770
9 sections

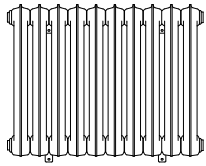

660 x 852
10 sections

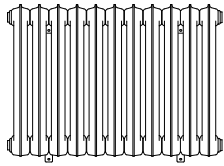

660 x 934
11 sections

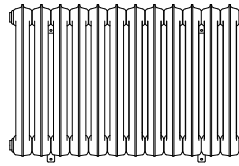

660 x 1016
12 sections

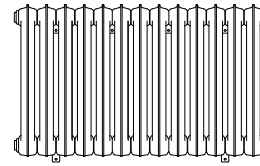

660 x 1098
13 sections

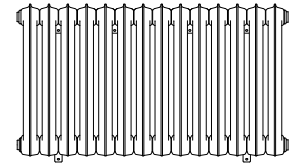

660 x 1180
14 sections

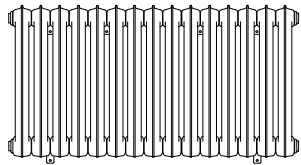

660 x 1262
15 sections

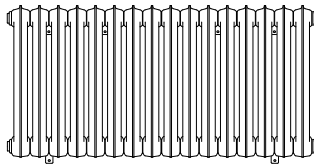

660 x 1344
16 sections

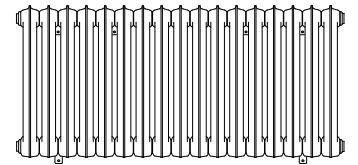

660 x 1426
17 sections



860 x 80
1 section

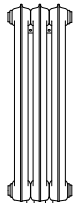

860 x 278
3 sections

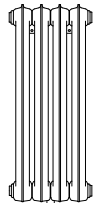

860 x 360
4 sections

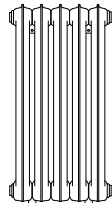

860 x 442
5 sections

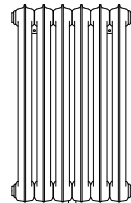

860 x 524
6 sections

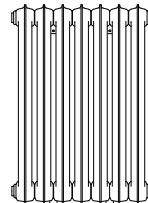

860 x 606
7 sections

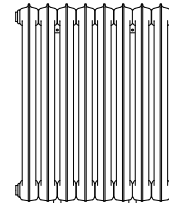

860 x 688
8 sections

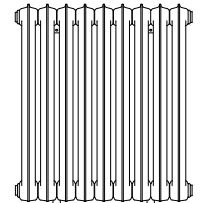

860 x 770
9 sections

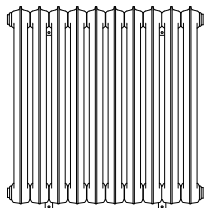

860 x 852
10 sections

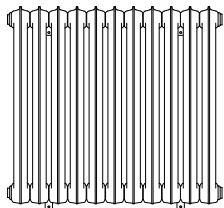

860 x 934
11 sections

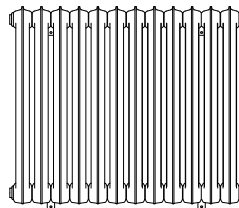

860 x 1016
12 sections

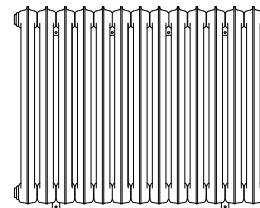

860 x 1098
13 sections

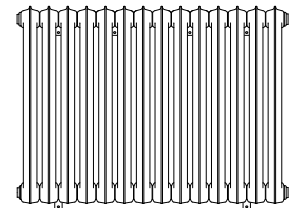

860 x 1180
14 sections

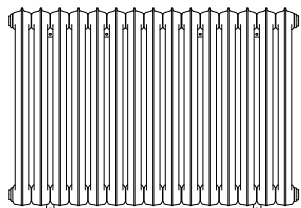

860 x 1262
15 sections

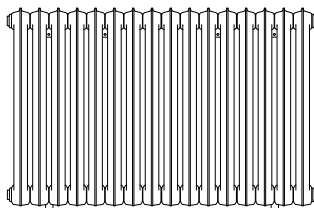

860 x 1344
16 sections

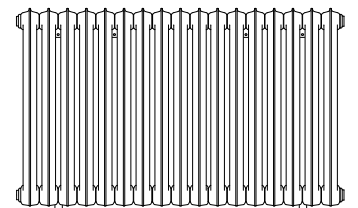

860 x 1426
17 sections

Free standing

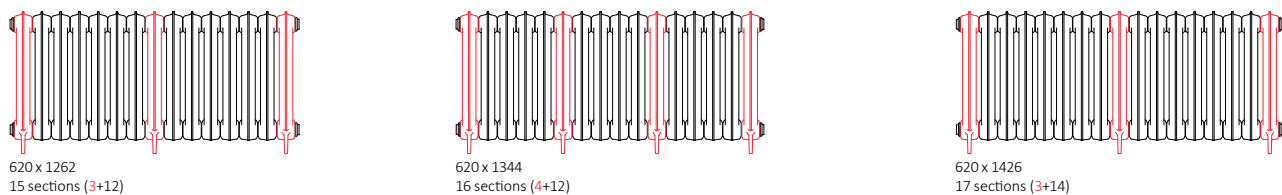
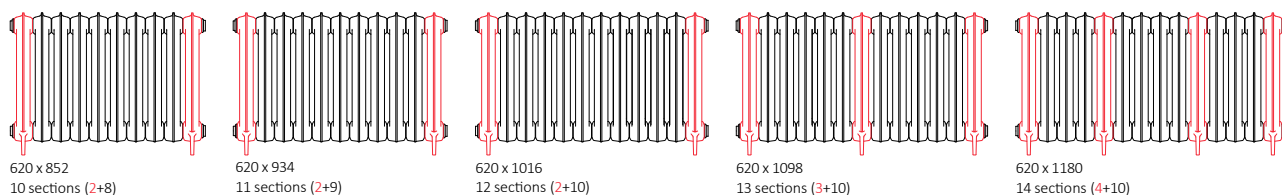
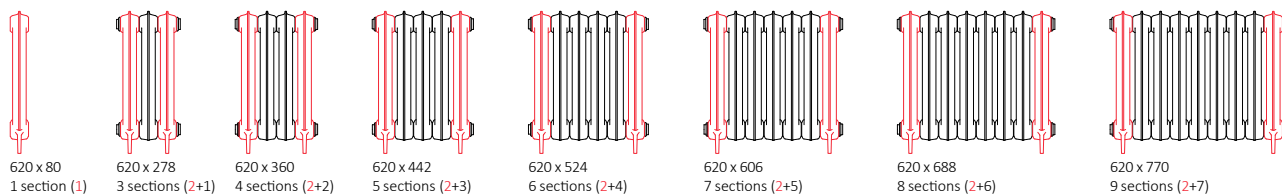
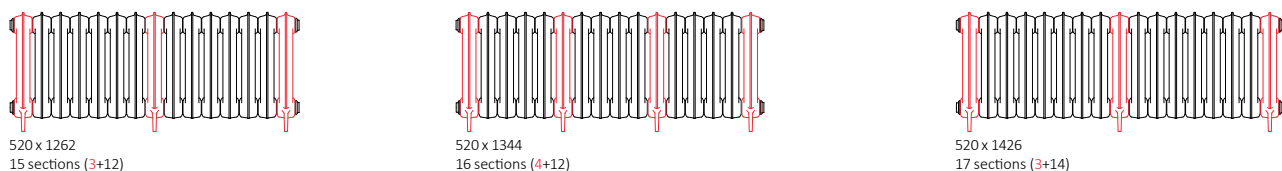
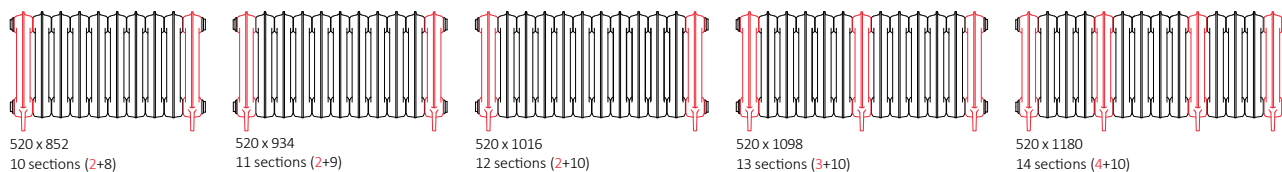
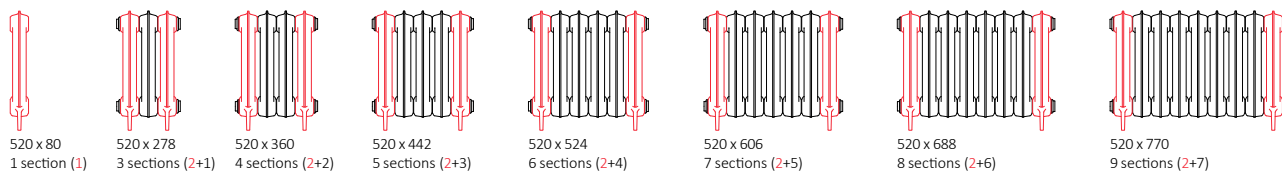

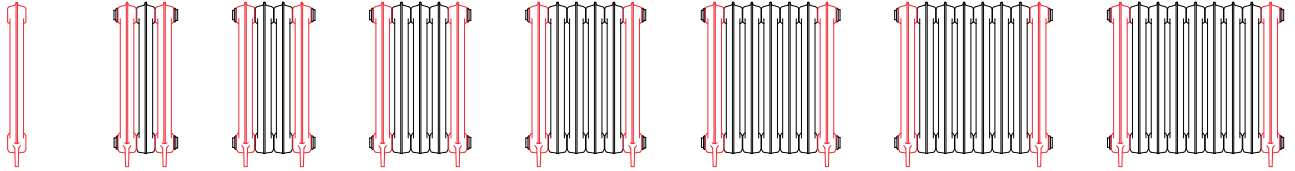

720 x 80 1 section (1) 720 x 278 3 sections (2+1) 720 x 360 4 sections (2+2) 720 x 442 5 sections (2+3) 720 x 524 6 sections (2+4) 720 x 606 7 sections (2+5) 720 x 688 8 sections (2+6) 720 x 770 9 sections (2+7)

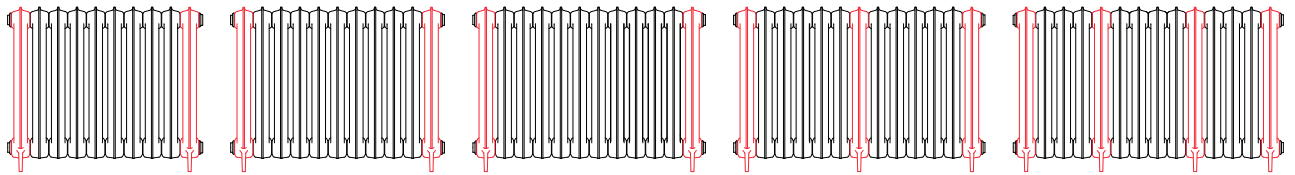

720 x 852 10 sections (2+8) 720 x 934 11 sections (2+9) 720 x 1016 12 sections (2+10) 720 x 1098 13 sections (3+10) 720 x 1180 14 sections (4+10)

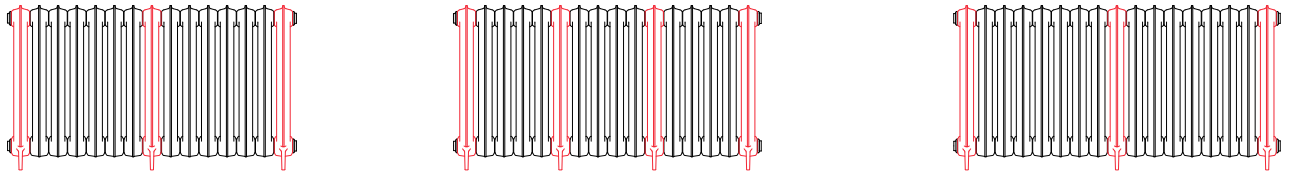

720 x 1262 15 sections (3+12) 720 x 1344 16 sections (4+12) 720 x 1426 17 sections (3+14)

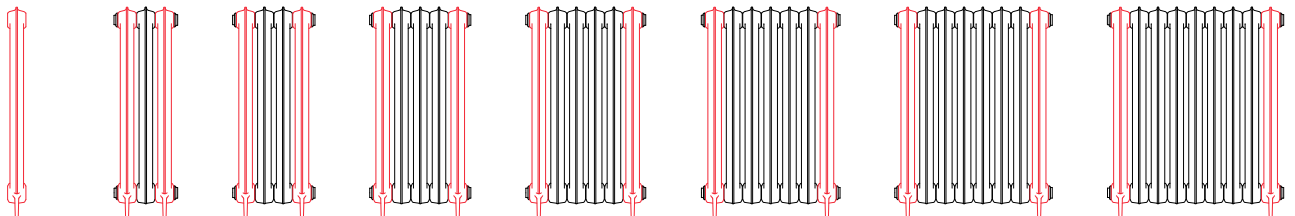

920 x 80 1 section (1) 920 x 278 3 sections (2+1) 920 x 360 4 sections (2+2) 920 x 442 5 sections (2+3) 920 x 524 6 sections (2+4) 920 x 606 7 sections (2+5) 920 x 688 8 sections (2+6) 920 x 770 9 sections (2+7)

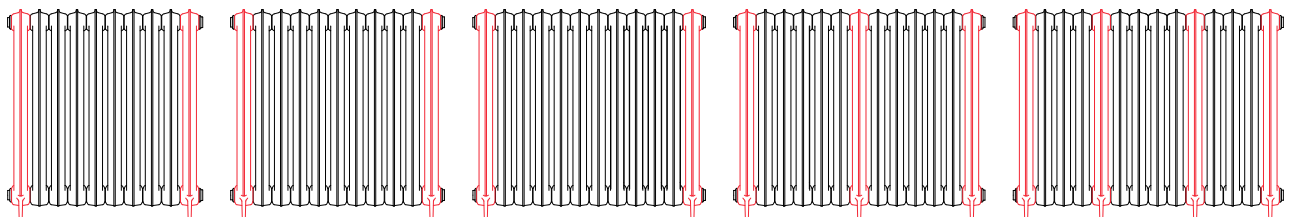

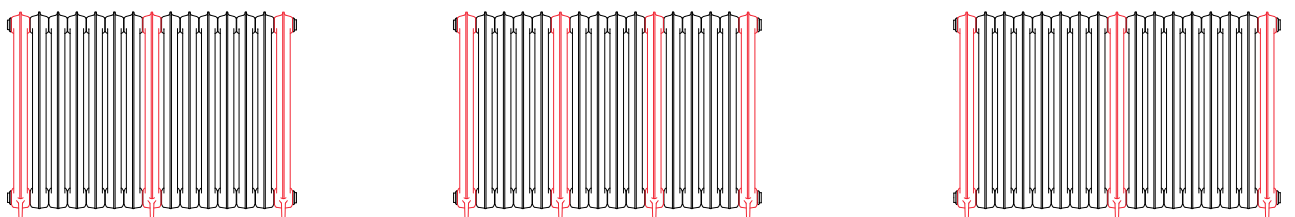

920 x 852 10 sections (2+8) 920 x 934 11 sections (2+9) 920 x 1016 12 sections (2+10) 920 x 1098 13 sections (3+10) 920 x 1180 14 sections (4+10)



920 x 1262 15 sections (3+12) 920 x 1344 16 sections (4+12) 920 x 1426 17 sections (3+14)

Specifications:

Working pressure: 1000 kPa Maximum operating temperature: 95°C

A ↑ [mm]	B ↔ [mm]	C [mm]	75/65/20°C [W]	55/45/20°C [W]	D [mm]	D1 [mm]	D2 [mm]	 [dm ³]	 [kg]	Product code <small>(Configuration code p. 787)</small>
Wall mounted										
460	80	360	86	46	—	—	—	2,13	7,30	WGPLB046008
460	278	360	259	137	82	98	—	6,38	23,00	WGPLB046027
460	360	360	345	183	—	98	—	8,50	30,30	WGPLB046036
460	442	360	432	228	246	98	—	10,63	37,60	WGPLB046044
460	524	360	518	274	—	98	—	12,75	44,90	WGPLB046052
460	606	360	604	320	246	180	—	14,88	52,20	WGPLB046060
460	688	360	690	365	328	180	—	17,01	59,50	WGPLB046068
460	770	360	777	411	410	180	—	19,13	66,80	WGPLB046077
460	852	360	863	457	492	180	—	21,26	74,10	WGPLB046085
460	934	360	949	503	574	180	—	23,38	81,40	WGPLB046093
460	1016	360	1036	548	656	180	—	25,51	88,70	WGPLB046101
460	1098	360	1122	594	738	180	246	27,63	96,00	WGPLB046109
460	1180	360	1208	640	820	180	246	29,76	103,30	WGPLB046118
460	1262	360	1295	685	902	180	246	31,89	110,60	WGPLB046126
460	1344	360	1381	731	984	180	246	34,01	117,90	WGPLB046134
460	1426	360	1467	777	1066	180	246	36,14	125,20	WGPLB046142
560	80	460	103	54	—	—	—	2,61	8,90	WGPLB056008
560	278	460	308	163	82	98	—	7,82	23,00	WGPLB056027
560	360	460	410	217	—	98	—	10,42	30,30	WGPLB056036
560	442	460	513	271	246	98	—	13,03	37,60	WGPLB056044
560	524	460	615	325	—	98	—	15,63	44,90	WGPLB056052
560	606	460	718	379	246	180	—	18,24	52,20	WGPLB056060
560	688	460	820	434	328	180	—	20,85	59,50	WGPLB056068
560	770	460	923	488	410	180	—	23,45	66,80	WGPLB056077
560	852	460	1025	542	492	180	—	26,06	74,10	WGPLB056085
560	934	460	1128	596	574	180	164	28,66	81,40	WGPLB056093
560	1016	460	1230	650	656	180	164	31,27	88,70	WGPLB056101
560	1098	460	1333	705	738	180	246	33,87	96,00	WGPLB056109
560	1180	460	1435	759	820	180	246	36,48	103,30	WGPLB056118
560	1262	460	1538	813	902	180	246	39,09	110,60	WGPLB056126
560	1344	460	1640	867	984	180	246	41,69	117,90	WGPLB056134
560	1426	460	1743	921	1066	180	246	44,30	125,20	WGPLB056142
660	80	560	124	66	—	—	—	3,05	9,50	WGPLB066008
660	278	560	372	198	82	98	—	9,16	29,60	WGPLB066027
660	360	560	496	265	—	98	—	12,21	39,10	WGPLB066036

We recommend: Angled manual valve set Minimalist for LP connection – see page 678





Pipe masking set – 160 mm – see page 681



Specifications:

Working pressure: 1000 kPa Maximum operating temperature: 95°C

A ↑ [mm]	B ↔ [mm]	C [mm]	75 65 20°C [W]	55 45 20°C [W]	D [mm]	D1 [mm]	D2 [mm]	 [dm ³]	 [kg]	Product code <small>(Configuration code p. 787)</small>
Wall mounted										
580	80	500	73	39	–	–	–	0,68	4,6	WGBRB058008
580	278	500	218	116	82	98	–	2,04	15,1	WGBRB058027
580	360	500	291	154	–	98	–	2,72	19,9	WGBRB058036
580	442	500	364	193	246	98	–	3,4	24,7	WGBRB058044
580	524	500	436	232	–	98	–	4,08	29,5	WGBRB058052
580	606	500	509	270	410	180	–	4,76	34,3	WGBRB058060
580	688	500	582	309	492	180	–	5,44	39,1	WGBRB058068
580	770	500	654	347	410	180	–	6,12	43,9	WGBRB058077
580	852	500	727	386	492	180	–	6,8	48,7	WGBRB058085
580	934	500	800	425	574	180	–	7,48	53,5	WGBRB058093
580	1016	500	872	463	656	180	–	8,16	58,3	WGBRB058101
580	1098	500	945	502	738	180	–	8,84	63,1	WGBRB058109
580	1180	500	1018	540	820	180	–	9,52	67,9	WGBRB058118
580	1262	500	1091	579	902	180	–	10,2	72,7	WGBRB058126
580	1344	500	1163	618	984	180	246	10,88	77,5	WGBRB058134
580	1426	500	1236	656	1066	180	246	11,56	82,3	WGBRB058142
Free standing										
640	80	500	73	39	–	–	–	0,68	5	WGBRF064008
640	278	500	218	116	–	–	–	2,04	15,9	WGBRF064027
640	360	500	291	154	–	–	–	2,72	20,7	WGBRF064036
640	442	500	364	193	–	–	–	3,4	25,5	WGBRF064044
640	524	500	436	232	–	–	–	4,08	30,3	WGBRF064052
640	606	500	509	270	–	–	–	4,76	35,1	WGBRF064060
640	688	500	582	309	–	–	–	5,44	39,9	WGBRF064068
640	770	500	654	347	–	–	–	6,12	44,7	WGBRF064077
640	852	500	727	386	–	–	–	6,8	49,5	WGBRF064085
640	934	500	800	425	–	–	–	7,48	49,3	WGBRF064093
640	1016	500	872	463	–	–	–	8,16	59,1	WGBRF064101
640	1098	500	945	502	–	–	–	8,84	63,9	WGBRF064109
640	1180	500	1018	540	–	–	–	9,52	68,7	WGBRF064118
640	1262	500	1091	579	–	–	–	10,2	73,9	WGBRF064126
640	1344	500	1163	618	–	–	–	10,88	79,1	WGBRF064134
640	1426	500	1236	656	–	–	–	11,56	83,5	WGBRF064142

Radiators made up of 13 sections and more are delivered in two or more batteries.

We recommend: Angled manual valve set Classic Art for LP connection – see page 677



Pipe masking set Artistic – see page 681



Free standing

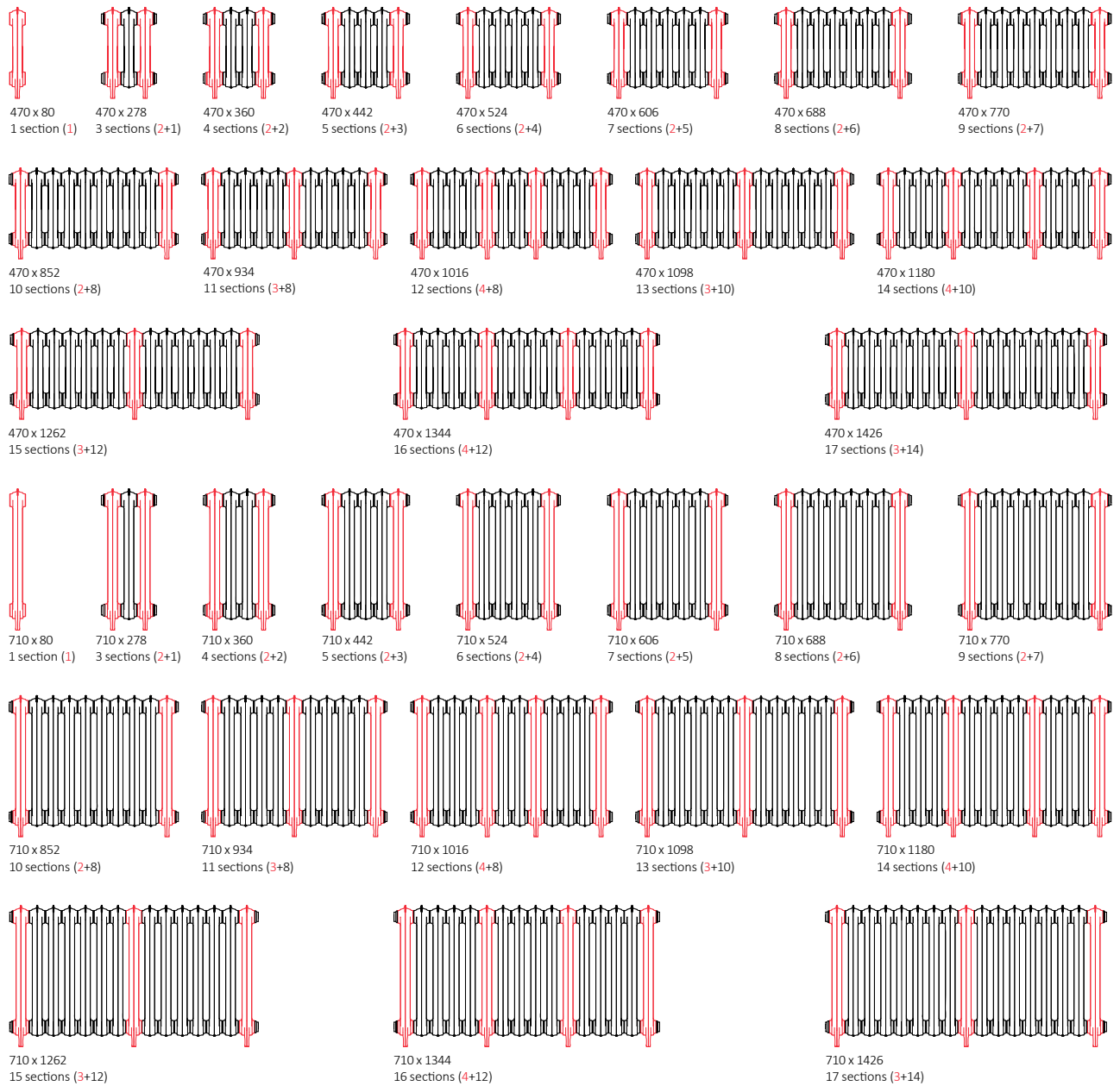

We recommend: Angled manual valve set Minimalist
for LP connection— see page 678



Pipe masking set – 160 mm
– see page 681

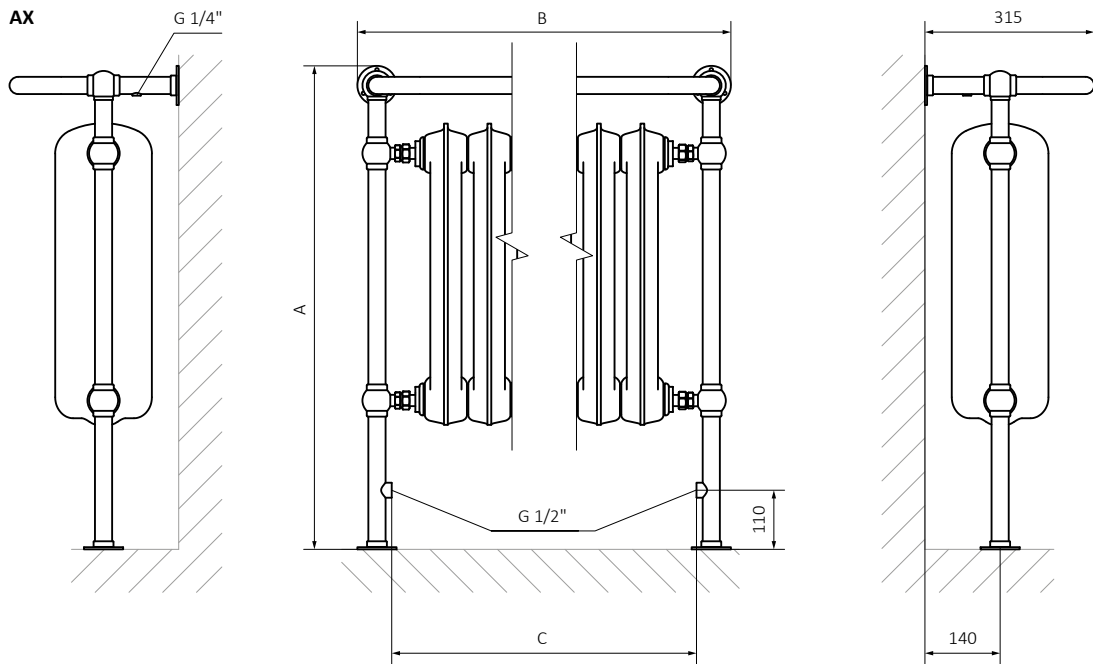
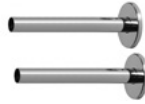

A – Height B – Width C – Distance between pipe centres

Plain Towel Rail s. 38



design: *Terma*

Standard connections:



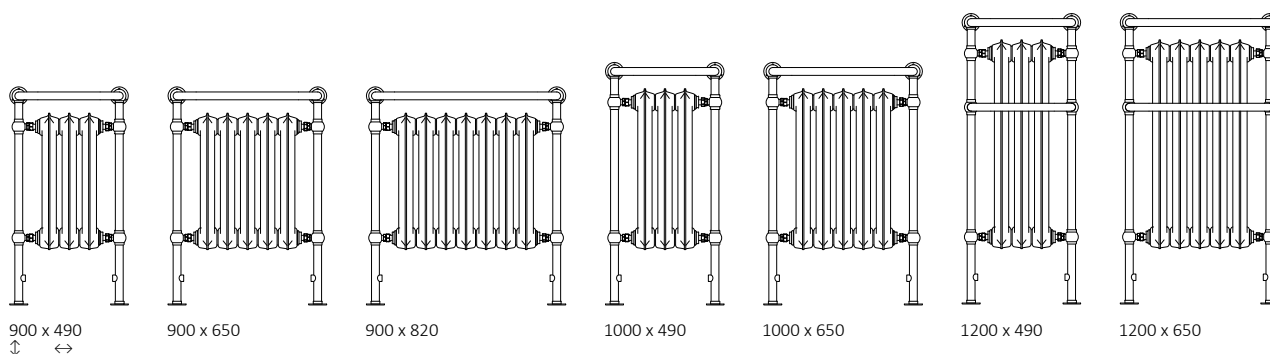

Available sizes:



Specifications:

Working pressure: 1000 kPa Maximum operating temperature: 95°C

A ↓ [mm]	B ↔ [mm]	C [mm]	75/65/20°C [W]	55/45/20°C [W]	 [dm³]	 [kg]	Product code <small>(Configuration code p. 787)</small>
900	490	366	357	190	9,62	37.00	WGNTR090049
900	650	530	595	317	14,93	55.00	WGNTR090065
900	820	694	834	445	20,24	73.00	WGNTR090082
1000	490	366	416	221	11,06	40.00	WGNTR100049
1000	650	530	694	368	17,37	61.00	WGNTR100065
1200	490	366	619	324	15,02	50.00	WGNTR120049
1200	650	530	1031	539	23,60	73.00	WGNTR120065

Wall mounted

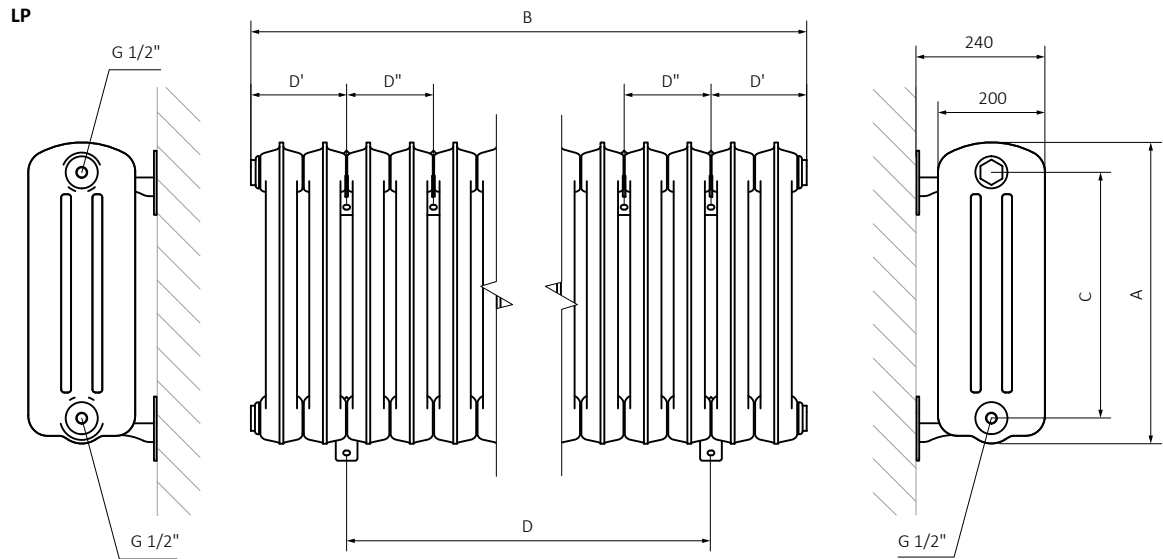

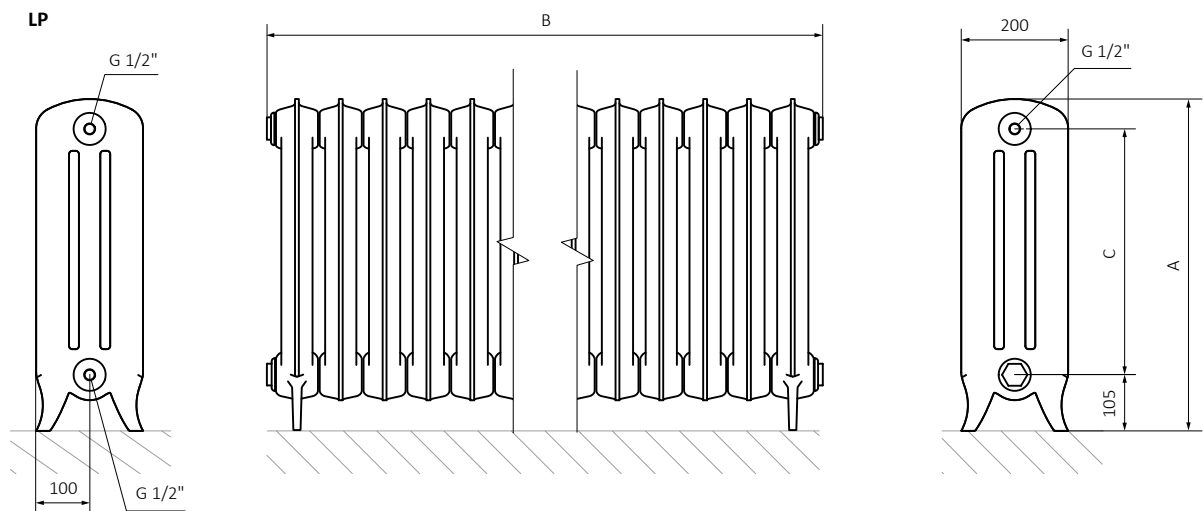

Free standing







A – Height B – Width C – Distance between pipe centres D – Horizontal distance between mounting bracket centres

Plain 3 column s. 34



A ↑ [mm]	B ↔ [mm]	C [mm]	75/65/20°C [W]	55/45/20°C [W]	D [mm]	D1 [mm]	D2 [mm]	 [dm ³]	 [kg]	Product code <small>(Configuration code p. 787)</small>
720	934	560	1518	797	–	–	–	31,90	130,54	WGP3F072093
720	1016	560	1656	870	–	–	–	34,80	142,58	WGP3F072101
720	1098	560	1794	942	–	–	–	37,70	153,32	WGP3F072109
720	1180	560	1932	1015	–	–	–	40,60	164,06	WGP3F072118
720	1262	560	2070	1087	–	–	–	43,50	177,40	WGP3F072126
720	1344	560	2208	1160	–	–	–	46,40	188,13	WGP3F072134
720	1426	560	2346	1232	–	–	–	49,30	201,47	WGP3F072142
920	80	760	176	92	–	–	–	3,80	16,18	WGP3F092008
920	278	760	528	277	–	–	–	11,40	49,06	WGP3F092027
920	360	760	704	369	–	–	–	15,20	64,64	WGP3F092036
920	442	760	880	462	–	–	–	19,00	80,22	WGP3F092044
920	524	760	1056	554	–	–	–	22,80	95,80	WGP3F092052
920	606	760	1232	647	–	–	–	26,60	111,38	WGP3F092060
920	688	760	1408	739	–	–	–	30,40	126,96	WGP3F092068
920	770	760	1584	831	–	–	–	34,20	142,54	WGP3F092077
920	852	760	1760	924	–	–	–	38,00	158,12	WGP3F092085
920	934	760	1936	1016	–	–	–	41,80	173,70	WGP3F092093
920	1016	760	2112	1108	–	–	–	45,60	189,28	WGP3F092101
920	1098	760	2288	1201	–	–	–	49,40	205,65	WGP3F092109
920	1180	760	2464	1293	–	–	–	53,20	222,03	WGP3F092118
920	1262	760	2640	1385	–	–	–	57,00	236,81	WGP3F092126
920	1344	760	2816	1478	–	–	–	60,80	253,19	WGP3F092134
920	1426	760	2992	1570	–	–	–	64,60	267,97	WGP3F092142



Radiators made up of 13 sections and more are delivered in two or more batteries.

A ↑ [mm]	B ↔ [mm]	C [mm]	75/65 [W]	55/45 [W]	D [mm]	D1 [mm]	D2 [mm]	 [dm ³]	 [kg]	Product code <small>(Configuration code p. 787)</small>
860	442	760	880	462	246	98	–	19,00	78,62	WGP3B086044
860	524	760	1056	554	–	98	–	22,80	94,20	WGP3B086052
860	606	760	1232	647	246	180	–	26,60	109,78	WGP3B086060
860	688	760	1408	739	328	180	–	30,40	125,36	WGP3B086068
860	770	760	1584	831	410	180	–	34,20	140,94	WGP3B086077
860	852	760	1760	924	492	180	–	38,00	156,52	WGP3B086085
860	934	760	1936	1016	574	180	164	41,80	172,10	WGP3B086093
860	1016	760	2112	1108	656	180	164	45,60	187,68	WGP3B086101
860	1098	760	2288	1201	738	180	246	49,40	203,25	WGP3B086109
860	1180	760	2464	1293	820	180	246	53,20	218,83	WGP3B086118
860	1262	760	2640	1385	902	180	246	57,00	234,41	WGP3B086126
860	1344	760	2816	1478	984	180	246	60,80	249,99	WGP3B086134
860	1426	760	2992	1570	1066	180	246	64,60	265,57	WGP3B086142
Free standing										
620	80	460	119	63	–	–	–	2,60	10,52	WGP3F062008
620	278	460	357	190	–	–	–	7,80	32,27	WGP3F062027
620	360	460	476	253	–	–	–	10,40	42,39	WGP3F062036
620	442	460	595	316	–	–	–	13,00	52,51	WGP3F062044
620	524	460	714	380	–	–	–	15,60	62,62	WGP3F062052
620	606	460	833	443	–	–	–	18,20	72,74	WGP3F062060
620	688	460	952	506	–	–	–	20,80	82,86	WGP3F062068
620	770	460	1071	569	–	–	–	23,40	92,97	WGP3F062077
620	852	460	1190	633	–	–	–	26,00	103,09	WGP3F062085
620	934	460	1309	696	–	–	–	28,60	113,21	WGP3F062093
620	1016	460	1428	759	–	–	–	31,20	123,33	WGP3F062101
620	1098	460	1547	822	–	–	–	33,80	134,04	WGP3F062109
620	1180	460	1666	886	–	–	–	36,40	144,76	WGP3F062118
620	1262	460	1785	949	–	–	–	39,00	154,28	WGP3F062126
620	1344	460	1904	1012	–	–	–	41,60	165,00	WGP3F062134
620	1426	460	2023	1075	–	–	–	44,20	174,51	WGP3F062142
720	80	560	138	72	–	–	–	2,90	12,64	WGP3F072008
720	278	560	414	217	–	–	–	8,70	34,24	WGP3F072027
720	360	560	552	290	–	–	–	11,60	46,27	WGP3F072036
720	442	560	690	362	–	–	–	14,50	58,31	WGP3F072044
720	524	560	828	435	–	–	–	17,40	70,35	WGP3F072052
720	606	560	966	507	–	–	–	20,30	82,39	WGP3F072060
720	688	560	1104	580	–	–	–	23,20	94,43	WGP3F072068
720	770	560	1242	652	–	–	–	26,10	106,47	WGP3F072077
720	852	560	1380	725	–	–	–	29,00	118,50	WGP3F072085

A ↑ [mm]	B ↔ [mm]	C [mm]	75/65 [W]	55/45 [W]	D [mm]	D1 [mm]	D2 [mm]	 [dm ³]	 [kg]	Product code <small>(Configuration code p. 787)</small>
660	442	560	620	331	246	98	–	15,27	48,60	WGPLB066044
660	524	560	744	397	–	98	–	18,32	58,10	WGPLB066052
660	606	560	868	463	246	180	–	21,37	67,60	WGPLB066060
660	688	560	992	529	328	180	–	24,42	77,10	WGPLB066068
660	770	560	1116	595	410	180	–	27,48	86,60	WGPLB066077
660	852	560	1240	661	492	180	–	30,53	96,10	WGPLB066085
660	934	560	1364	728	574	180	164	33,58	105,60	WGPLB066093
660	1016	560	1488	794	656	180	164	36,64	115,10	WGPLB066101
660	1098	560	1612	860	738	180	246	39,69	124,60	WGPLB066109
660	1180	560	1736	926	820	180	246	42,74	134,10	WGPLB066118
660	1262	560	1860	992	902	180	246	45,80	143,60	WGPLB066126
660	1344	560	1984	1058	984	180	246	48,85	153,10	WGPLB066134
660	1426	560	2108	1124	1066	180	246	51,90	162,60	WGPLB066142
860	80	760	149	80	–	–	–	4,14	11,70	WGPLB086008
860	278	760	447	239	82	98	–	12,42	36,20	WGPLB086027
860	360	760	596	318	–	98	–	16,56	47,90	WGPLB086036
860	442	760	745	398	246	98	–	20,70	59,60	WGPLB086044
860	524	760	894	477	–	98	–	24,84	71,30	WGPLB086052
860	606	760	1043	557	246	180	–	28,98	83,00	WGPLB086060
860	688	760	1192	636	328	180	–	33,12	94,70	WGPLB086068
860	770	760	1341	716	410	180	–	37,26	106,40	WGPLB086077
860	852	760	1490	795	492	180	–	41,40	118,10	WGPLB086085
860	934	760	1639	875	574	180	164	45,54	129,80	WGPLB086093
860	1016	760	1788	954	656	180	164	49,68	141,50	WGPLB086101
860	1098	760	1937	1034	738	180	246	53,82	153,20	WGPLB086109
860	1180	760	2086	1113	820	180	246	57,96	164,90	WGPLB086118
860	1262	760	2235	1193	902	180	246	62,10	176,60	WGPLB086126
860	1344	760	2384	1272	984	180	246	66,24	188,30	WGPLB086134
860	1426	760	2533	1352	1066	180	246	70,38	200,00	WGPLB086142
Free standing										
520	80	360	86	46	–	–	–	2,13	7,70	WGPLF052008
520	278	360	259	137	–	–	–	6,38	23,80	WGPLF052027
520	360	360	345	183	–	–	–	8,50	31,10	WGPLF052036
520	442	360	432	228	–	–	–	10,63	38,40	WGPLF052044
520	524	360	518	274	–	–	–	12,75	45,70	WGPLF052052
520	606	360	604	320	–	–	–	14,88	53,00	WGPLF052060
520	688	360	690	365	–	–	–	17,01	60,30	WGPLF052068
520	770	360	777	411	–	–	–	19,13	67,60	WGPLF052077
520	852	360	863	457	–	–	–	21,26	74,90	WGPLF052085

Plain s. 32

A ↑ [mm]	B ↔ [mm]	C [mm]	75/65/20°C [W]	55/45/20°C [W]	D [mm]	D1 [mm]	D2 [mm]	 [dm ³]	 [kg]	Product code <small>(Configuration code p. 787)</small>
520	934	360	949	503	—	—	—	23,38	82,20	WGPLF052093
520	1016	360	1036	548	—	—	—	25,51	89,50	WGPLF052101
520	1098	360	1122	594	—	—	—	27,63	97,20	WGPLF052109
520	1180	360	1208	640	—	—	—	29,76	104,90	WGPLF052118
520	1262	360	1295	685	—	—	—	31,89	111,80	WGPLF052126
520	1344	360	1381	731	—	—	—	34,01	119,50	WGPLF052134
520	1426	360	1467	777	—	—	—	36,14	126,40	WGPLF052142
620	80	460	103	54	—	—	—	2,61	9,30	WGPLF062008
620	278	460	308	163	—	—	—	7,82	27,50	WGPLF062027
620	360	460	410	217	—	—	—	10,42	36,40	WGPLF062036
620	442	460	513	271	—	—	—	13,03	45,30	WGPLF062044
620	524	460	615	325	—	—	—	15,63	54,20	WGPLF062052
620	606	460	718	379	—	—	—	18,24	63,10	WGPLF062060
620	688	460	820	434	—	—	—	20,85	72,00	WGPLF062068
620	770	460	923	488	—	—	—	23,45	80,90	WGPLF062077
620	852	460	1025	542	—	—	—	26,06	89,80	WGPLF062085
620	934	460	1128	596	—	—	—	28,66	98,70	WGPLF062093
620	1016	460	1230	650	—	—	—	31,27	107,60	WGPLF062101
620	1098	460	1333	705	—	—	—	33,87	116,90	WGPLF062109
620	1180	460	1435	759	—	—	—	36,48	126,20	WGPLF062118
620	1262	460	1538	813	—	—	—	39,09	134,70	WGPLF062126
620	1344	460	1640	867	—	—	—	41,69	144,00	WGPLF062134
620	1426	460	1743	921	—	—	—	44,30	152,50	WGPLF062142
720	80	560	124	66	—	—	—	3,05	10,10	WGPLF072008
720	278	560	372	198	—	—	—	9,16	30,80	WGPLF072027
720	360	560	496	265	—	—	—	12,21	40,30	WGPLF072036
720	442	560	620	331	—	—	—	15,27	49,80	WGPLF072044
720	524	560	744	397	—	—	—	18,32	59,30	WGPLF072052
720	606	560	868	463	—	—	—	21,37	68,80	WGPLF072060
720	688	560	992	529	—	—	—	24,42	78,30	WGPLF072068
720	770	560	1116	595	—	—	—	27,48	87,80	WGPLF072077
720	852	560	1240	661	—	—	—	30,53	97,30	WGPLF072085
720	934	560	1364	728	—	—	—	33,58	106,80	WGPLF072093
720	1016	560	1488	794	—	—	—	36,64	116,30	WGPLF072101
720	1098	560	1612	860	—	—	—	39,69	126,40	WGPLF072109
720	1180	560	1736	926	—	—	—	42,74	136,50	WGPLF072118
720	1262	560	1860	992	—	—	—	45,80	145,40	WGPLF072126
720	1344	560	1984	1058	—	—	—	48,85	155,50	WGPLF072134
720	1426	560	2108	1124	—	—	—	51,90	164,40	WGPLF072142

A ↑ [mm]	B ↔ [mm]	C [mm]	75/65 [W] 20°C	55/45 [W] 20°C	D [mm]	D1 [mm]	D2 [mm]	 [dm ³]	 [kg]	Product code <small>(Configuration code p. 787)</small>
920	80	760	149	80	—	—	—	4,14	12,50	WGPLF092008
920	278	760	447	239	—	—	—	12,42	37,80	WGPLF092027
920	360	760	596	318	—	—	—	16,56	49,50	WGPLF092036
920	442	760	745	398	—	—	—	20,70	61,20	WGPLF092044
920	524	760	894	477	—	—	—	24,84	72,90	WGPLF092052
920	606	760	1043	557	—	—	—	28,98	84,60	WGPLF092060
920	688	760	1192	636	—	—	—	33,12	96,30	WGPLF092068
920	770	760	1341	716	—	—	—	37,26	108,00	WGPLF092077
920	852	760	1490	795	—	—	—	41,40	119,70	WGPLF092085
920	934	760	1639	875	—	—	—	45,54	132,20	WGPLF092093
920	1016	760	1788	954	—	—	—	49,68	144,70	WGPLF092101
920	1098	760	1937	1034	—	—	—	53,82	155,60	WGPLF092109
920	1180	760	2086	1113	—	—	—	57,96	168,10	WGPLF092118
920	1262	760	2235	1193	—	—	—	62,10	179,00	WGPLF092126
920	1344	760	2384	1272	—	—	—	66,24	191,50	WGPLF092134
920	1426	760	2533	1352	—	—	—	70,38	202,40	WGPLF092142

Radiators made up of 13 sections and more are delivered in two or more batteries.

Wall mounted

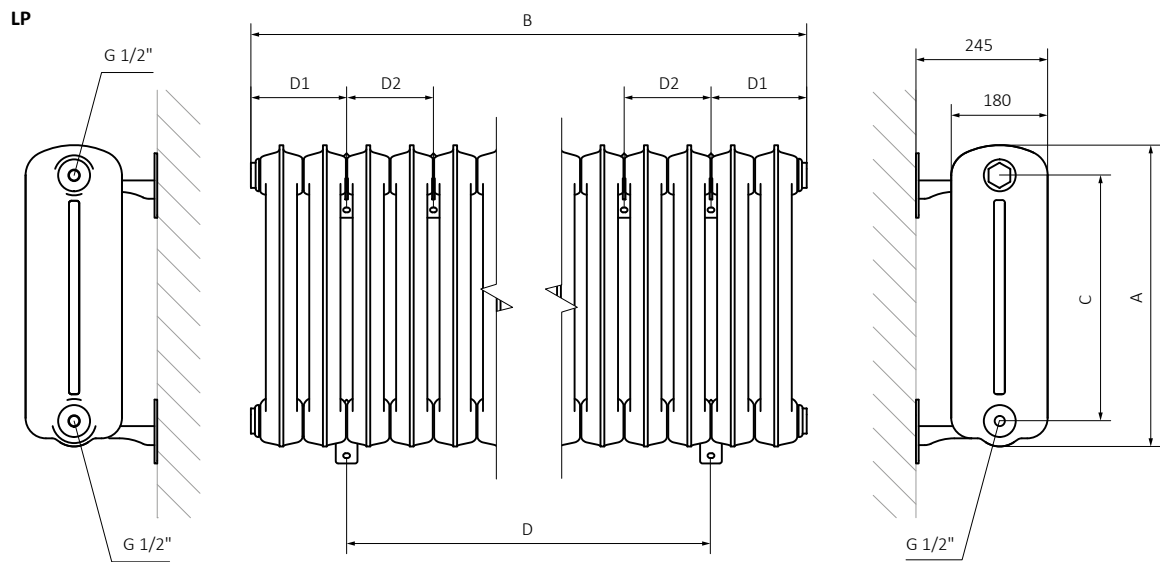

A – Height B – Width C – Distance between pipe centres D – Horizontal distance between mounting bracket centres

Free standing

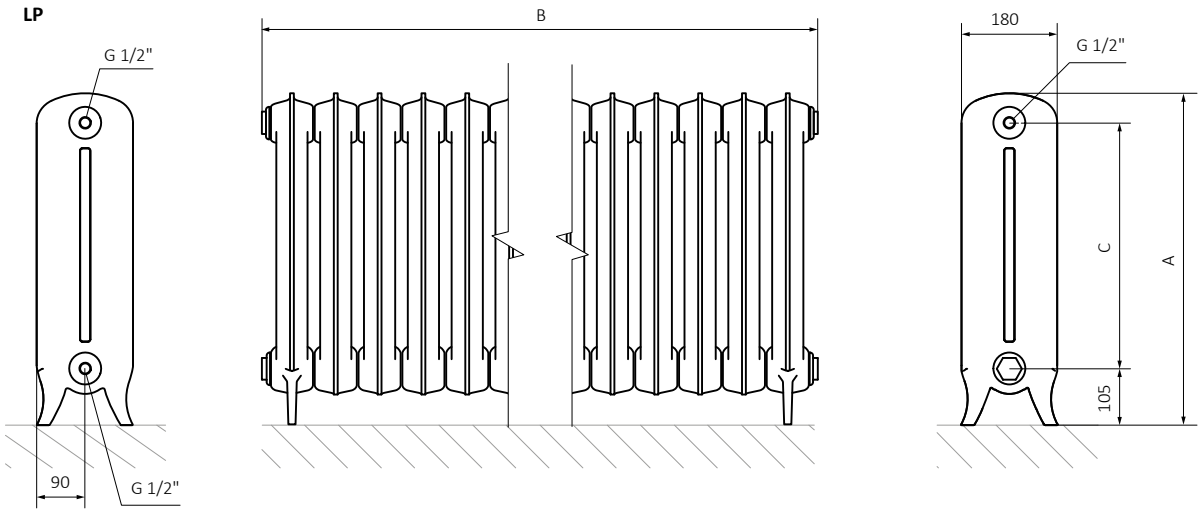

Plain 3 column s. 34



design: *Terma*

Standard connections:



Available sizes:

Wall mounted

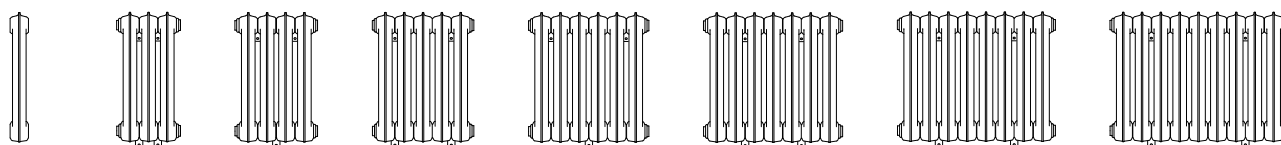

560 x 80 1 section 560 x 278 3 sections 560 x 360 4 sections 560 x 442 5 sections 560 x 524 6 sections 560 x 606 7 sections 560 x 688 8 sections 560 x 770 9 sections

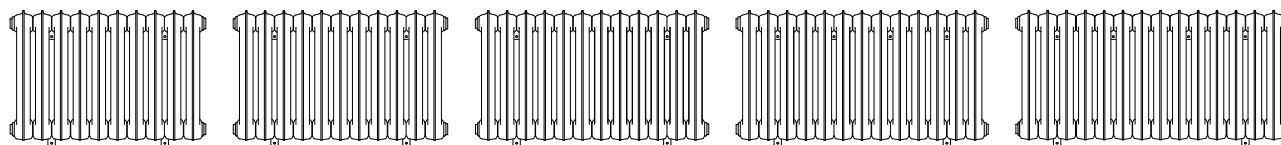

560 x 852 10 sections 560 x 934 11 sections 560 x 1016 12 sections 560 x 1098 13 sections 560 x 1180 14 sections

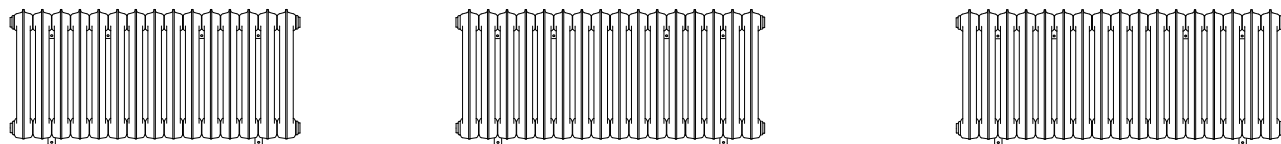

560 x 1262 15 sections 560 x 1344 16 sections 560 x 1426 17 sections

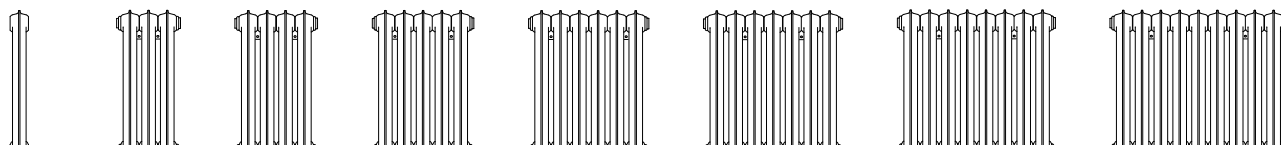

660 x 80 1 section 660 x 278 3 sections 660 x 360 4 sections 660 x 442 5 sections 660 x 524 6 sections 660 x 606 7 sections 660 x 688 8 sections 660 x 770 9 sections

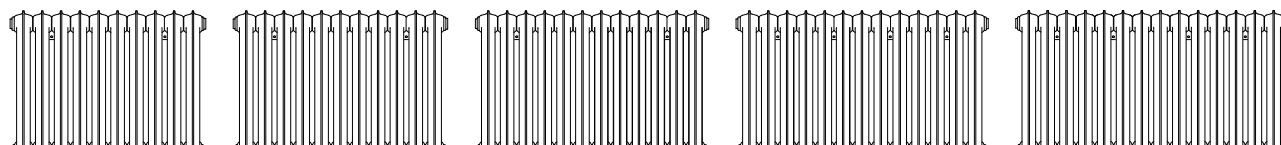

660 x 852 10 sections 660 x 934 11 sections 660 x 1016 12 sections 660 x 1098 13 sections 660 x 1180 14 sections

We recommend: WOOD thermostatic angled valve set
for LP connection – see page 680



Pipe masking set – 160 mm
– see page 681

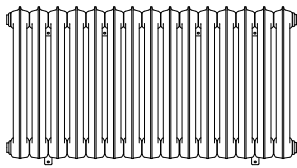

660 x 1262
15 sections

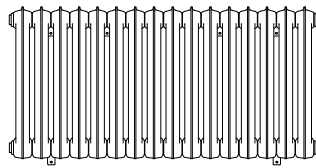

660 x 1344
16 sections

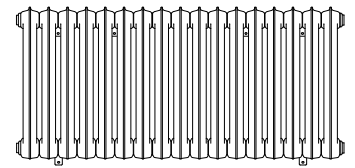

660 x 1426
17 sections



860 x 80
1 section

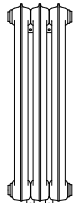

860 x 278
3 sections

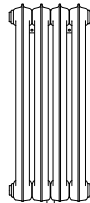

860 x 360
4 sections

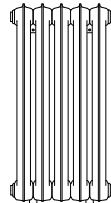

860 x 442
5 sections

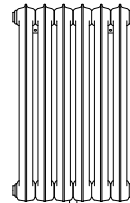

860 x 524
6 sections

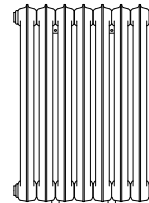

860 x 606
7 sections

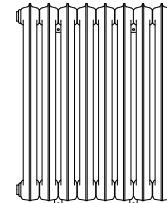

860 x 688
8 sections

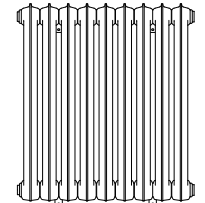

860 x 770
9 sections

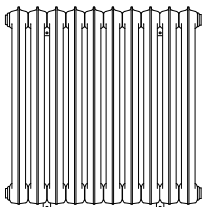

860 x 852
10 sections

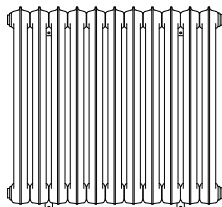

860 x 934
11 sections

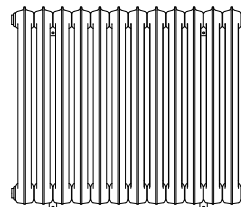

860 x 1016
12 sections

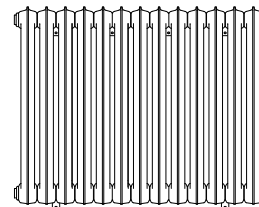

860 x 1098
13 sections

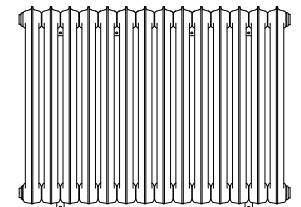

860 x 1180
14 sections

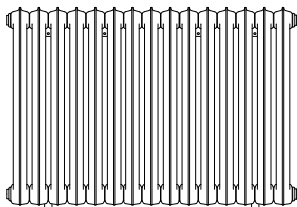

860 x 1262
15 sections

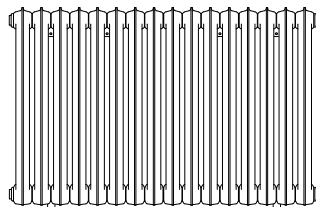

860 x 1344
16 sections

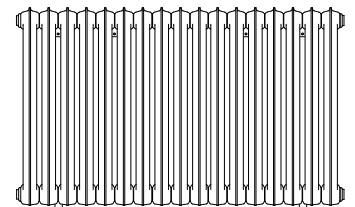

860 x 1426
17 sections

Plain 3 column s. 34

Free standing



620 x 80
1 section (1)

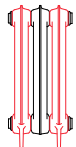

620 x 278
3 sections (2+1)

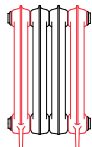

620 x 360
4 sections (2+2)

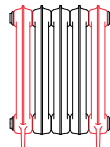

620 x 442
5 sections (2+3)

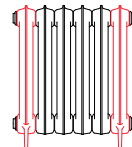

620 x 524
6 sections (2+4)

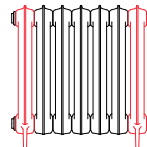

620 x 606
7 sections (2+5)

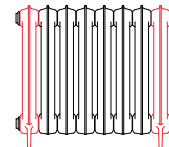

620 x 688
8 sections (2+6)

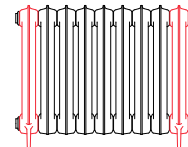

620 x 770
9 sections (2+7)

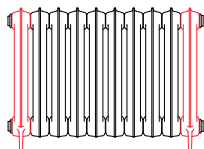

620 x 852
10 sections (2+8)

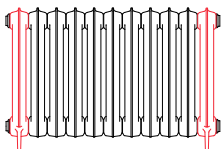

620 x 934
11 sections (2+9)

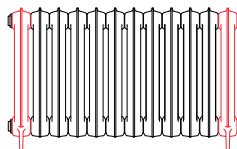

620 x 1016
12 sections (2+10)

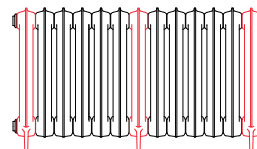

620 x 1098
13 sections (3+10)

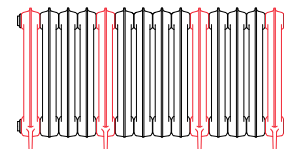

620 x 1180
14 sections (4+10)

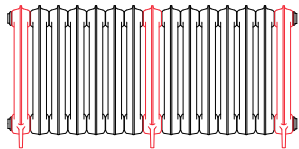

620 x 1262
15 sections (3+12)

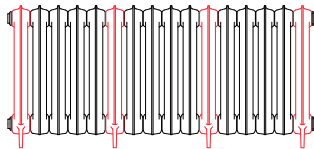

620 x 1344
16 sections (4+12)

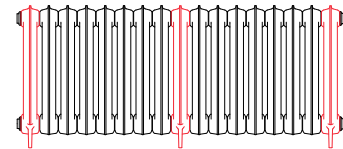

620 x 1426
17 sections (3+14)



720 x 80
1 section (1)

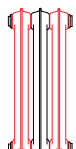

720 x 278
3 sections (2+1)

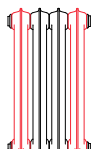

720 x 360
4 sections (2+2)

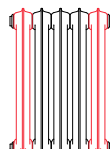

720 x 442
5 sections (2+3)

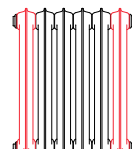

720 x 524
6 sections (2+4)

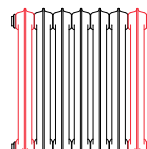

720 x 606
7 sections (2+5)

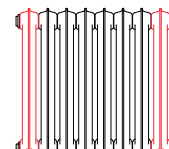

720 x 688
8 sections (2+6)

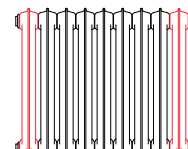

720 x 770
9 sections (2+7)

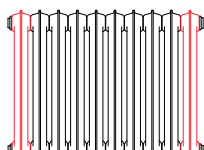

720 x 852
10 sections (2+8)

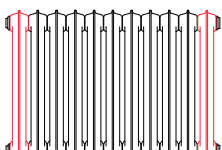

720 x 934
11 sections (2+9)

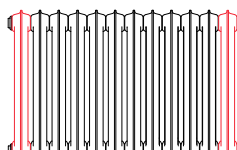

720 x 1016
12 sections (2+10)

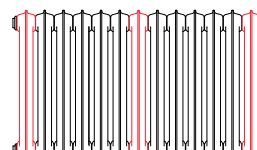

720 x 1098
13 sections (3+10)

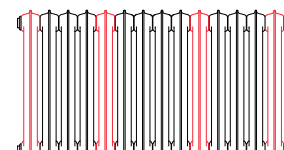

720 x 1180
14 sections (4+10)

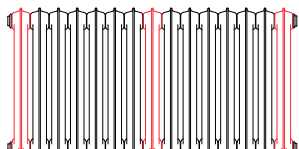

720 x 1262
15 sections (3+12)

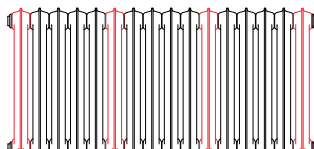

720 x 1344
16 sections (4+12)

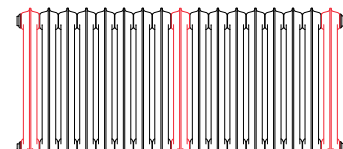

720 x 1426
17 sections (3+14)



920 x 80
1 section (1)

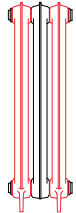

920 x 278
3 sections (2+1)



920 x 360
4 sections (2+2)



920 x 442
5 sections (2+3)

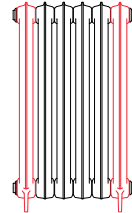

920 x 524
6 sections (2+4)

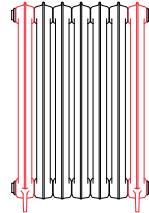

920 x 606
7 sections (2+5)

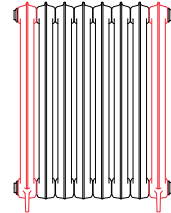

920 x 688
8 sections (2+6)

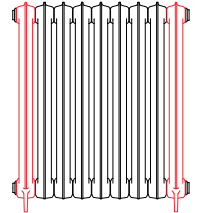

920 x 770
9 sections (2+7)

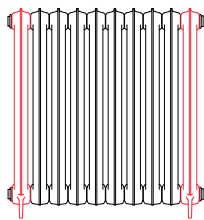

920 x 852
10 sections (2+8)

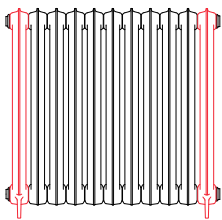

920 x 934
11 sections (2+9)

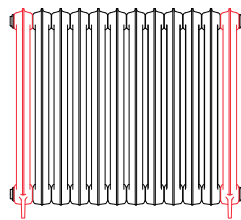

920 x 1016
12 sections (2+10)

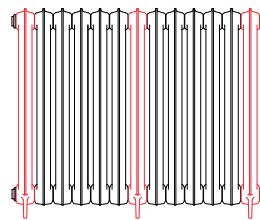

920 x 1098
13 sections (3+10)

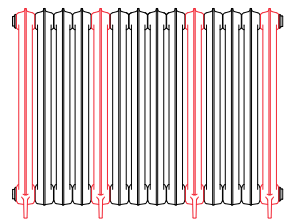

920 x 1180
14 sections (4+10)

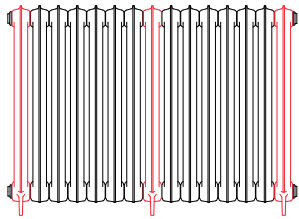

920 x 1262
15 sections (3+12)

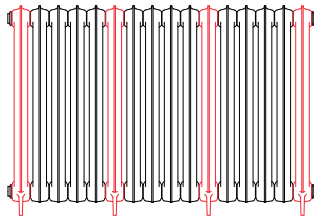

920 x 1344
16 sections (4+12)

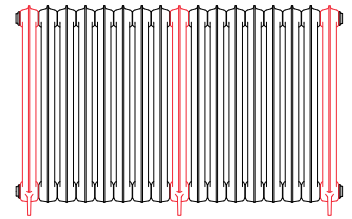

920 x 1426
17 sections (3+14)

Plain 3 column s. 34

Specifications:

Working pressure: 1000 kPa Maximum operating temperature: 95°C

A ↑ [mm]	B ↔ [mm]	C [mm]	75/65/20°C [W]	55/45/20°C [W]	D [mm]	D1 [mm]	D2 [mm]	H [dm ³]	 [kg]	Product code <small>(Configuration code p. 787)</small>
Wall mounted										
560	80	460	119	63	–	–	–	2,60	9,92	WGP3B056008
560	278	460	357	190	82	98	–	7,80	31,07	WGP3B056027
560	360	460	476	253	–	98	–	10,40	41,19	WGP3B056036
560	442	460	595	316	246	98	–	13,00	51,31	WGP3B056044
560	524	460	714	380	–	98	–	15,60	61,42	WGP3B056052
560	606	460	833	443	246	180	–	18,20	71,54	WGP3B056060
560	688	460	952	506	328	180	–	20,80	81,66	WGP3B056068
560	770	460	1071	569	410	180	–	23,40	91,77	WGP3B056077
560	852	460	1190	633	492	180	–	26,00	101,89	WGP3B056085
560	934	460	1309	696	574	180	164	28,60	112,01	WGP3B056093
560	1016	460	1428	759	656	180	164	31,20	122,13	WGP3B056101
560	1098	460	1547	822	738	180	246	33,80	132,24	WGP3B056109
560	1180	460	1666	886	820	180	246	36,40	142,36	WGP3B056118
560	1262	460	1785	949	902	180	246	39,00	152,48	WGP3B056126
560	1344	460	1904	1012	984	180	246	41,60	162,60	WGP3B056134
560	1426	460	2023	1075	1066	180	246	44,20	172,71	WGP3B056142
660	80	560	138	72	–	–	–	2,90	11,84	WGP3B066008
660	278	560	414	217	82	98	–	8,70	36,84	WGP3B066027
660	360	560	552	290	–	98	–	11,60	48,87	WGP3B066036
660	442	560	690	362	246	98	–	14,50	60,91	WGP3B066044
660	524	560	828	435	–	98	–	17,40	72,95	WGP3B066052
660	606	560	966	507	246	180	–	20,30	84,99	WGP3B066060
660	688	560	1104	580	328	180	–	23,20	97,03	WGP3B066068
660	770	560	1242	652	410	180	–	26,10	109,07	WGP3B066077
660	852	560	1380	725	492	180	–	29,00	121,10	WGP3B066085
660	934	560	1518	797	574	180	164	31,90	133,14	WGP3B066093
660	1016	560	1656	870	656	180	164	34,80	145,18	WGP3B066101
660	1098	560	1794	942	738	180	246	37,70	157,22	WGP3B066109
660	1180	560	1932	1015	820	180	246	40,60	169,26	WGP3B066118
660	1262	560	2070	1087	902	180	246	43,50	181,30	WGP3B066126
660	1344	560	2208	1160	984	180	246	46,40	193,33	WGP3B066134
660	1426	560	2346	1232	1066	180	246	49,30	205,37	WGP3B066142
860	80	760	176	92	–	–	–	3,80	15,38	WGP3B086008
860	278	760	528	277	82	98	–	11,40	47,46	WGP3B086027
860	360	760	704	369	–	98	–	15,20	63,04	WGP3B086036